

Busy Bee Tools



busybeetools.com 1-800-461-BUSY (2879) Sale ends August 8th, 2015

Nebo Slyde Flashlight and Worklight Combo

- Features a powerful LED flashlight and COB work light all in one.
- Simply slide to reveal work light.
- Try it out in store, you will be impressed by the power and overall high quality.



\$39⁹⁹
6156 - Reg. \$47.99

7.5 Amp Deluxe Plate Joiner



- Plate joiner kit handles a variety of wood and feature 7 cutting settings
- Industry-leading 7-amp motor rotates blade at 10,000 RPM
- Comes with 4-inch blade, centering plate, spanner wrench, dust bag, and chip deflector

*While Quantities Last
\$229
557 - Reg. \$299.00



Titebond III Ultimate Wood Glue



Titebond III Ultimate Wood Glue is the first one-part, water cleanup wood glue ever offered that is proven waterproof. Titebond III is non-toxic, solvent free and cleans up with water - safer to use than traditional waterproof wood glues. It provides strong initial tack, sands easily without softening and is FDA approved for indirect food contact (cutting boards). The ultimate in wood glues - ideal for both interior and exterior applications. 25 oz.

Best Seller!

\$19⁹⁹ Buy 3+ **\$17⁹⁹** Each
B2515 - Reg. \$26.99

WORK SHARP Knife and Tool Sharpener Ken Onion Edition

Adjustable Sharpening Guide with variable speed heavy duty motor provides fast, precise and repeatable sharpening results with no set up or calibration time. Improved cooling and the option of slow speed honing to high speed grinding.



\$179
WSKTSKOC - Reg. \$199



Lumber Rack 6 Shelf System



- 110 lbs. of capacity per level
- Shelf depth: 12 1/4"

\$34⁹⁹
CT177 - Reg. \$59.99

High Visibility Safety Vest



- This one-size fits most safety vest features pockets, fade resistant material and made from 100% polyester mesh.
- 5 tear away points at the shoulders, sides and front ensure the user is always visible and safe.

\$6⁹⁹
B3291 - Reg. \$9.99



8" Parallelogram Jointer



With H.S.S. Cutter Head
\$1385
CX08 - Reg. \$1599

With Spiral Cutter Head
\$1825
CX08SC - Reg. \$1999

- 3 HP, 220V, 1 PH
- Integrated Mobile Base



14" x 40" Gear Head Engine Lathe



- Main motor: 3 HP, 220V, 1 Ph.
- Taper headstock/tailstock: MT5/MT3
- Spindle bore: 1 1/2"
- Number of spindle speeds: 8, 90 - 1800 RPM
- Net weight: 750 kg.
- 2 Year Warranty

\$6999
CT042 - Reg. \$7699

THE Right TOOLS. THE Right PEOPLE. THE Right PRICE.

CONTRACTOR ZONE



new



Line Site Automatic Self Leveling Laser

The LSL105 Laser with Aluminum Tripod and 5m Rod is a high quality self levelling auto laser designed for the pro.

Applications include: Site Work and Levelling, Machine Control, Interiors, Alignment & Layout

- Recommended Use: 500m (1,500 ft.) Diameter with Receiver
- Accuracy: $\pm 3\text{mm} @ 30\text{m}$ ($1/8" @ 100\text{ft.}$)
- Rotating Speeds: 600 RPM
- Battery Life: Approximately 15 hours

B3280 - Reg. \$799.00

\$599

10" Kapro Apollo Box Level with Plumb Site



new

- 3 solid acrylic vials
- Shockproof, solid acrylic vials - one level, one plumb, and one incline
- Accuracy: 0.0005 in/inches (0.5mm/m)

B3285 - Reg. \$31.00

\$24⁹⁹

new

Line Site 28X Builders Level

Perfect kit used in construction, survey, rental or any other industry which requires marking and measuring



Includes: Tripod & Rod, Auto Air Dampened Compensator, Smooth double sided endless fine drive for accurate & precise targeting & Water Resistant Construction

B3281 - Reg. \$399.00

\$299

Arctic "Pink & Orange Glo" Flagging Tape



new

- Withstands temperatures of -35°C
- 125ft long, 1" wide and 5.2mm thick

- Built in UV protection

Model	Color	Reg.	Price
B3288	Orange	\$1.99	\$1.49
B3289	Pink	\$1.99	\$1.49

Kapro Apollo Magnetic Box Level



new

- Magnified vertical and horizontal vials
- Plumb Site dual-view vial with the unique dual view of the Plumb Site vial
- Solid acrylic shockproof vials, epoxy-locked within the level frame
- Shockproof bi-material rubber end caps offer optimized impact resistance
- Tough reinforced aluminum box section profile

Model	Size	Reg.	Price
B3282	24"	\$ 84.00	\$ 64.99
B3283	48"	\$118.00	\$ 89.99
B3284	72"	\$178.00	\$139.99

72" Level is available in-store only

Kapro 340-08D Magnetic Folding Post Level

new



- Folds closed, opens flat, and locks every 15° to accommodate different pipe, post, and beam sizes to 6" in diameter
- Acrylic vials - two level and one plumb

- Comes with 4 magnets for metal surfaces

B3286 - Reg. \$14.99

\$10⁹⁹

Makita Drywall Cutout Tool



new

- Collet Capacities: $1/8"$ (3.18 mm), $1/4"$ (6.35 mm)
- 120V, 5.0 AMPS
- No. Load Speed: 32,000 RPM

Includes

- $1/8"$ Drywall Guide Bit, $1/8"$ Collet Cone, $1/4"$ Collet Cone, Wrench 13, Wrench Holder

3706 - Reg. \$159.99

\$99⁹⁹

16 oz Hammer with 13.5" Fiberglass Handle

new



- Features a curved fiberglass handle with non-slip rubber grip
- Weight: 16 oz
- Handle: 13.5" Fiberglass

B3293 - Reg. \$13.99

\$6⁹⁹

500W Portable Halogen Work Light



new

- Comfort grip carrying handle for portability
- 500W halogen bulb
- Wide base for stability
- Adjustable head

B3302 - Reg. \$24.99

\$18⁹⁹

STANLEY

1.6 HP Continuous 200 PSI 15 Gallon Compressor



- Horsepower: 1.6 HP
- Tank Size: 15 Gallon
- Power Supply: 120 Volts
- CFM@100 PSI: 5.0 SCFM
- Pump Speed: 1,750 RPM

HOT DEAL

While Qts. Last!

FMFP12829 - Reg. \$469.00

\$299

Cross Laser Line

- Projects bright crossing horizontal and vertical lines for various leveling and layout applications
- Maintains full brightness for visibility and extends range



\$149

DW088K - Reg. \$199.99

38pc Impact Ready Accessory Set



- Hardened steel screw driver bits
- Comes with storage case for easy storage and portability
- Contains most commonly used bits

\$42⁹⁹

DW2169C - Reg. \$59

7-1/4" Thin Kerf Framing Blade



- 24-Teeth
- Tougher tungsten carbide stays sharper longer
- Specially formulated anti-stick coating minimizes friction and gum-up for smoother cuts

\$7⁹⁹

DW3578B10 - Reg. \$15.99

8 Piece Combination Wrench Set

- Lockable Stacking Cases
- Durable Transparent Lid
- 8pc Long Panel Combination Wrenches for long reach and leverage.
- Exceeds ANSI Specifications



Toughlock Stacksys Drive Socket Set

- Lockable Stacking Cases
- Durable Transparent Lid



new

31pc Screwdriving Set Impact Ready



\$12⁹⁹

DWAX100IR - Reg. \$39.99

Model	Type	Reg. Price	SALE
DWMT73810	Imperial	\$50.99	\$39.99
DWMT73809	Metric	\$49.99	\$39.99

Model	Desc.	SALE
DWMT73805	25pc 1/4" Socket	\$39.99
DWMT73806	17pc 3/8" Deep Socket	\$29.99
DWMT73807	15pc 1/2" Drive	\$35.99

2-1/4 HP Plunge- and Fixed-Base Variable-Speed Router Kit



- Electronic variable speed with full feedback control
- 8,000-24,000 rpm with soft start to reduce start-up torque for enhanced control

\$239

DW618PK - Reg. \$341.99

1-1/4 HP Max Torque Variable Speed Compact Router Combo Kit with LED's



- Variable speed control
- Soft starting motor
- Dual LED to ensure maximum visibility during operation

\$195

DWP611PK - Reg. \$239.99

6-1/2" TrackSaw Kit with 59" & 102" Track



- Zero clearance TrackSaw™ cutting system delivers precise, straight, splinter-free cuts
- Powerful 12A, 1300W motor

\$639

DWS520CK - Reg. \$729

20" Variable Speeds Scroll Saw with BONUS Stand & Lamp



Features

- Up front controls
- Electronic variable speed
- Multi-directional dust blower
- Tool-less blade change
- Ratcheting tension lever
- Permanent magnet motor
- Heavy Duty Stand
- Handy Work Lamp

Specifications

- Motor: 1.3 amps, 400-1750 SPM
- Stroke length: 3/4"
- Table 16" x 24": 45° right and left
- Throat: 20"
- Height capacity: 2"
- Weight: 43 Kgs

\$529

DW788BS - Reg. \$629

10" Wet Tile Saw with Portable Stand



- Cantilevering Rail/Cart system allows for 24" ripping capacity - 18" tile on diagonal
- Only 69 lbs - allows one person to transport and set up saw
- Amps: 15.0 amps
- Blade Diameter: 10"
- Max Rip Capacity: 24"
- Diagonal Cut Capacity: 18"
- Tool Weight: 69 lbs
- Plunge Feature: Yes
- Max Depth of Cut: 3-1/8"

\$799

D24000S - Reg. \$1049

DEWALT®

GUARANTEED TOUGH.®

All items strictly while quantities last

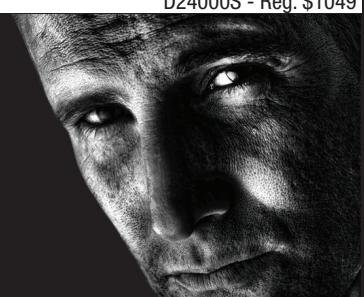

Power Tools All Items Are Limited Quantities

SKIL 7 1/4" Lightweight Circular Saw with Carbide Blade

new



\$119
Model SPT67WL22
Reg. \$199.00

- 15 AMP
- **Includes:** 7-1/4" circular saw, 24-tooth Diablo carbide blade, multi-function wrench stored in the foot.

SKIL Flooring Saw

new



\$165
Model 360102
Reg. \$229.00

- Cuts solid, engineered and laminate flooring with ease
- Makes cross, miter and rip cuts
- Limited 3 Year Warranty

DREMEL Dremel Versa Flame

new



\$45
Model 220001
Reg. \$59.99

- No independent ignition tool required
- Features variable control for both torch and flame operation

Makita Variable Speed Jig Saw

new



\$89.99
Model 4329K
Reg. \$115.00

- Model T101B5 - T101B Jigsaw Blade 5pc **\$5.99**
- Model T101BR5 - T101BR Jigsaw Blade 5pc **\$5.99**

Makita 1 1/4 HP Plunge Router

new



\$149
Model RP0900K
Reg. \$199.00

- 120V, 8.0 AMP
- **Includes:** 1/4" Collet Cone, Wrench 13, Wrench 22, Straight Guide, Plastic Carrying Case

BOSCH 12" Dual Bevel Glide Miter Saw

\$749
Model GCM12SD
Reg. \$879.00



- 15 AMP
- Bevel angle range: 48° left, 48° right
- Blade diameter: 12"
- Miter angle range: 52° left & 60° right
- No Load: 3,800 RPM

BOSCH Portable Jobsite Table Saw

new



\$429
Model GTS10310S
Reg. \$449.00

- **FREE!** Includes A Stand
Model GTA500 Value \$49.99
- **Includes:** 10" 24 Tooth Carbide Saw Blade; Rip Fence; Miter Gauge; Smart Guard System; Push Stick; Blade Change Wrenches

\$50.00 INSTANT REBATE ON THESE **Makita** KITS. VALID MAY 15th TO JUNE 30th, 2015

18V, Hammer/Impact Combo



After Rebate

\$239
Model LXT211
Reg. \$499.00

Kit Includes: A Hammer Drill, An Impact Driver, 2 18-V (3.0 Ah) Li-Ion Batteries, Charger and a Plastic Carrying Case.

18V Driver/Impact Combo



After Rebate

\$235
Model LXT220
Reg. \$429.99

1/2" Cordless Driver Drill, 1/4" Cordless Impact Driver, 2 Ea. 18V (3.0 Ah) Li-Ion Batteries, BL1830, Charger & Plastic Carrying Case.

18V, 4 Ah Cordless Combo Kit



new

After Rebate

\$349
Model DLX2005M
Reg. \$449.00

1/4" Cordless Impact Driver with Brushless Motor, 1/2" Cordless Hammer Driver Drill with Brushless Motor, 2 Ea. 18V (4.0 Ah) Li-Ion Batteries BL1840, Charger & Plastic Carrying Case.

Makita 18V Lithium-Ion Battery Packs



BL1830 BL1840



BL1850

Model	Amp/H	Reg.	SALE
BL1830	3.0	\$119.00	\$ 84.99
BL1840	4.0	\$149.00	\$109.00
BL1850	5.0	\$149.99	\$139.99

DEWALT 20V MAX* Premium XR Lithium Ion Battery



\$48.99
Model DCB203
Reg. \$109.00

- 3-LED Fuel Gauge System allows immediate feedback
- Quick 35 minute charge time

PORTER CABLE Multi Purpose Spray Gun



new

\$34.99
Model PCMT70527
Reg. \$45.00

- Average SCFM required at 50 PSI is 9.8
- Includes internal and external mix caps
- For use with lacquers, enamels and latex paints

DEWALT 1/2" Spade Handle Drill



\$159.99
Model DW130V
Reg. \$199.00

- For Drilling & Mud Mixing
- Motor: 9.0 Amps
- No Load Speed: 0-550 RPM
- **Includes:** 3-position side handle, Chuck key with holder, 2-position rear spade handle

Nailers & Staplers

CRAFTEX **2" Brad Nailer**
18 Gauge



2 Year Warranty

- Takes nails from: 19/32" - 2"

\$41.99
Model CT111
Reg. \$55.00

CRAFTEX **Narrow Crown Stapler**
18 Gauge



2 Year Warranty

While Qtys. Last!

- Takes staples from: 13/32" - 1"

\$24.99
Model CT114
Re.g. \$49.99

CRAFTEX **2 in 1 - 2" Nailer/Stapler**
18 Gauge



2 Year Warranty

- Takes nails from: 25/32" - 2" & Takes staples from: 5/8" - 1 5/8"

\$47.50
Model CT113
Re.g. \$59.99

CRAFTEX CX-SERIES **2" Brad Nailer**



3 Year Warranty

\$51.50
Model CX901
Re.g. \$65.00

CRAFTEX **1 3/8" Pin Nailer**, 23 Gauge



2 Year Warranty

\$57.99
Model CT176
Reg. \$69.99

- Required Pressure: 60 - 100 psi
- Air Inlet: 1/4" NPT
- Range: 1/2" to 1 3/8"

Capacity: 200 Nails

1/4" Female Coupler



\$3.29
Model B1252C
Reg. \$5.99

5pc Quick Air Coupler Set



\$5.99
Model B1252
Reg. \$7.99

1 quick coupler & 4 connector.

Air Blow Gun 1/4"



\$3.99
Model B1076
Reg. \$4.99

- Drives 18 gauge nails from 5/8 to 2
- Working Pressure 60 to 100 PSI (max 120PSI)
- Capacity: 100pcs
- Comes complete with carry case, safety goggles, bottle of oil and hex wrenches.

Staples, Brads & Pin Nails

Model	Size	SALE
18 Gauge Staples Qty. 500		
CT1813S	1/2"	\$1.99
CT1816S	5/8"	\$1.99
CT1819S	3/4"	\$1.99
CT1822S	7/8"	\$2.49
CT1825S	1"	\$2.29
CT1832S	1 1/4"	\$2.99
CT1838S	1 1/2"	\$3.49
CT1840S	1 9/16"	\$3.49

Model	Size	SALE
18 Gauge Brads Qty. 1000		
CT1810N	3/8"	\$1.99
CT1815N	5/8"	\$1.99
CT1820N	3/4"	\$1.99
CT1825N	1"	\$2.29
CT1830N	1 3/16"	\$2.29
CT1832N	1 1/4"	\$2.29
CT1835N	1 3/8"	\$2.99

Model	Size	SALE
18 Gauge Brads Qty. 1000		
CT1838N	1 1/2"	\$3.49
CT1840N	1 9/16"	\$3.99
CT1845N	1 3/4"	\$3.49
CT1850N	2"	\$3.49
23 Gauge Nails Qty. 1000		
CT176100	1"	\$12.99
23 Gauge Nails Qty. 5000		
CT11912	1/2"	\$3.99
CT11915	5/8"	\$4.99

Recoil Air Hose



B1106 B1208
Keep air lines safe and secure.

Model	Size	Reg.	SALE
B1106	1/4" x 25'	\$6.99	\$4.99
B1208	1/4" x 50'	\$9.99	\$7.99

SHOP FOX **Air/Moisture Filter/Regulator w/Gauge**



\$39.99
Model D3271
Reg. \$49.99

- 150 PSI Maximum Pressure
- Locking Control Knob
- Accepts 1/4" NPT fittings

SHOP FOX **Air Moisture Filter Regulator with Lubricator**



\$45
Model D3272
Reg. \$55.00

This combo unit is great for controlling air pressure, trapping moisture and cleaning air in pneumatic system.

Wall mounting bracket included.

CAMPBELL HAUSFELD



MP211700AV

new



MP246800AV



MP284701AV



MP288300AV



MP321401AV



MP323101AV

Air Tool Accessories



MP323400AV



MP323600AV



MP323800AV



MP333500AV



MP333600AV



MP514100AV

Model	Size	Description	Reg.	SALE
MP211700AV	1/4" (NPT) (F)	Plug	\$ 3.99	\$ 1.99
MP246800AV	1/4" (NPT) (M)	Plug	\$ 3.99	\$ 1.99
MP284701AV	1/4"	Accessory Kit 17pc	\$21.99	\$14.99
MP288300AV	1/4" I/M NPT (F)	Coupler	\$ 6.99	\$ 3.99
MP321401AV	1/4"	Hose Repair Kit	\$ 3.99	\$ 2.29
MP323101AV	6"	Air Chuck Dual Foot	\$ 4.99	\$ 2.99
MP323400AV	1/4" I/M NPT (M)	Coupler	\$ 6.00	\$ 3.99
MP323600AV	1/4" (F)	Auto Coupler	\$ 6.00	\$ 3.99
MP323800AV	1/4" (M)	Auto Plug	\$ 3.99	\$ 1.99
MP333500AV	1/4" (F)	Universal Coupler	\$ 7.99	\$ 4.99
MP333600AV	1/4" (M)	Universal Coupler	\$ 7.99	\$ 4.99
MP514100AV		7pc Blow Gun Kit	\$10.99	\$ 6.99

MINI MILLING MACHINE



- ▶ 1/2 HP, 110V, 4.5 Amp
- ▶ Drill Cap: 1/2"
- ▶ Spindle Taper: R8
- ▶ Head Tilt: ±45°
- ▶ Variable Speeds
- ▶ Weight: 50 kg

~~\$1099~~ **\$975**

CX605

MILL DRILL w/R8 TAPER & DRO



- ▶ 3/4 HP, 110V, 1 PH
- ▶ Drilling Cap. 1"
- ▶ End Mill Cap. 5/8"
- ▶ Spindle Taper: R8
- ▶ Weight: 113 kg

~~\$1799~~ **\$1575**

Optional Stand for CX600
Model CX600ST - Reg. \$249 - Sale \$225 **CX600**

MILL/DRILL w/DIGITAL READOUT



- ▶ 1.5 HP, 110V, 1 PH
- ▶ Spindle Taper: R8
- ▶ Weight: 240 kg

~~\$2599~~ **\$2469**

Optional Stand for CX601
Model CX601ST - Reg. \$249 - Sale \$225 **CX601**

MINI MILLING MACHINE w/BRUSHLESS MOTOR



- ▶ Motor: 500 Watt, 110V, 60Hz, Brushless
- ▶ Drilling Capacity: 5/8"
- ▶ End Mill Capacity: 3/4"
- ▶ Face Mill Capacity: 1-3/8"
- ▶ Spindle Taper: R8
- ▶ Weight: 50 kg

~~\$1499~~ **\$1225**

Optional Stand for CX612
Model CX612T - Reg. \$299 - Sale \$239 **CX612**

MILLING DRILLING MACHINE Made in Taiwan



- ▶ 1.5 HP, 220V, 1 PH
- ▶ Drilling Capacity: 1 1/4"
- ▶ Face Mill: 3"
- ▶ End Mill Capacity: 3/4"
- ▶ Swing: 15-7/8"
- ▶ Spindle Taper: R8
- ▶ Spindle Stroke: 5"
- ▶ Weight: 300 kg

~~\$2499~~ **\$2199**

CX604

6" x 21" MILL / DRILL w/VARIABLE SPEED



- ▶ Motor: Brushless, 1000 Watt, 110V, 6 Amp, 60Hz
- ▶ Digital RPM display
- ▶ End Mill Capacity: 1"
- ▶ Weight: 165 kg

~~\$2899~~ **\$2499**

Optional Stand for CX611
Model CX611ST - Reg. \$499 - Sale \$425 **CX611**

10" x 22" METAL LATHE w/DIGITAL READOUT



- ▶ 1 HP, 110V
- ▶ Spindle Taper: MT4
- ▶ Weight: 145 kg

~~\$2499~~ **\$2199**

Optional Stand for CX706
Model CX706ST - Reg. \$249 - Sale \$225 **CX706**

12" x 28" METAL LATHE w/DIGITAL READOUT



- ▶ 1.5 HP, 110V
- ▶ 1.5" Spindle Bore
- ▶ Variable Speeds
- ▶ Weight: 250 kg

~~\$3499~~ **\$3199**

Optional Stand for CX701
Model CX701ST - Reg. \$249 - Sale \$225 **CX701**

12" x 36" GEAR HEAD METAL LATHE



- ▶ 2 HP, 110V
- ▶ Tailstock Taper MT3
- ▶ 1-7/16" Spindle Bore
- ▶ Weight: 400 kg

~~\$4299~~ **\$3899**

CX707

12-1/4" x 8-1/4" PORTABLE BENCH TOP METAL BANDSAW



- ▶ Motor: 300W
- ▶ Blade Size: 1/2"
- ▶ Weight: 110 kg

~~\$699~~ **\$529**

CX112 Made in Taiwan

7" x 12" METAL BANDSAW



- ▶ 1 HP, 110V, 1 PH
- ▶ Weight: 165 kg

Made in Taiwan

~~\$1499~~ **\$1299**

CX103

9" x 16" METAL BANDSAW



- ▶ 1.5 HP, 220V
- ▶ Weight: 285 kg

Made in Taiwan

~~\$4699~~ **\$4299**

CX107

new

SUPER 3 SPEED AIR CLEANER



AVAILABLE JUNE 2015

- ▶ 1/5 HP, 120-Volts, Single Phase, 60-Hz
- ▶ 5 micron primary filter
- ▶ 1 micron secondary filter
- ▶ Weight: 56 lbs.

CX407

~~\$399~~ **\$345**

2 HP DUST COLLECTOR w/CANISTER FILTER

Made in Taiwan



- ▶ 2HP, 220V, TEFC
- ▶ 1,700 CFM
- ▶ Static Pressure - 10"
- ▶ Bag Capacity - 5.7 cubic feet
- ▶ Inlet - 6" main with removable "Y"

CX400

~~\$649~~ **\$579**

3HP DUST COLLECTOR

Equipped with a 3 HP powerful motor and two collector rings, this heavy duty dust collector is designed to be used with machine groupings in larger shops.



- ▶ 3 HP, 220V, 1 Ph
- ▶ 2300 CFM
- ▶ 12.75" Impeller
- ▶ Weight: 75 kg

CX406 Made in Taiwan

~~\$749~~ **\$599**



14" ULTIMATE BANDSAW

This 14" Band Saw has the features & specifications found only in larger units, culminating in what can truly be called the Ultimate 14" Band Saw.

- ▶ 2 HP, 220V, 1 Ph
- ▶ Table size: 16" x 20" Precision Ground Cast Iron
- ▶ Weight: 136 kg

Made in Taiwan

CX100

~~\$1599~~ **\$1399**



10" CABINET TABLE SAW w/EXTENSION TABLE

Watch the video @ busybeetools.com

- ▶ 3 HP, 220V, 1 Ph Leeson Motor
- ▶ Table size - 27" x 73 3/4" w/Ext.
- ▶ Weight: 257 kg

CX201

~~\$2299~~ **\$1999**



12" CABINET TABLE SAW w/RIVING KNIFE

- ▶ 3 HP, 220V, 1 PH
- ▶ Table size - 30" x 48" (with extension wings)
- ▶ Max Depth of Cut @ 90° - 4", @ 45° - 2 5/8"
- ▶ Weight: 275 kg

Made in Taiwan

CX206

~~\$2499~~ **\$2099**

6" Jointer

With Spiral Cutterhead



- ▶ 1.5 HP, 220V, 110V
- ▶ Indexable Spiral Cutter-Head with 4 rows of German Made Carbide Tipped Inserts (32 replaceable inserts)

Watch the video @ busybeetools.com

CX06SC

~~\$1599~~ **\$1399**



6" PROFESSIONAL JOINTER

- ▶ 1 HP, 110V/220V, 1PH
- ▶ Cutterhead Speed - 4,800 RPM

Made in Taiwan

(3 H.S.S. Cutterhead)

(Spiral Cutterhead) **CX06**

~~\$799~~ **\$699**

MORTISING MACHINE w/TILTING HEAD

This heavy duty tilting head Mortiser features cast iron construction, a powerful 3/4HP motor, left/right tilting head for angled mortising & a solid quick release vise.



- ▶ 3/4 HP, 110V, 1 PH, 6 Amps
- ▶ Chisel Capacity - 1/4" to 5/8"
- ▶ Chuck Capacity - 1/2"
- ▶ Weight - 62 kg

~~\$565~~ **\$479**

Optional Stand for CX302 Model CX302ST - Reg. \$125 - Sale \$89

HEAVY DUTY BENCH TOP WOOD LATHE



- ▶ 1/2 HP, 110V, 1 PH
- ▶ Swing Over Bed: 10"
- ▶ Spindle TPI: 1" x 8 TPI
- ▶ Spindle Taper: MT2
- ▶ Weight: 45 kg

CX801

~~\$399~~ **\$339**

Optional 38" Extension for CX801 Model CX801EXT - Reg. \$139 - Sale \$115



15" HEAVY DUTY PLANER

- ▶ 3 HP, 220V, 1 Phase
- ▶ Weight: 285 kg

~~\$1799~~ **\$1599**

(3 H.S.S. Cutterhead) **CX15**

(Spiral Cutterhead) **CX15SC**

~~\$2899~~ **\$2650**

26" DRUM SANDER

Made in Taiwan

Watch the video @ busybeetools.com



- ▶ 3 HP, 220V, 1 PH
- ▶ Max. Board Thickness: 12"
- ▶ Min. Board Thickness: 1/4"
- ▶ Weight: 486 lbs

~~\$2999~~ **\$2499**

CX504



HIGH QUALITY MACHINERY BACKED BY A 3 YEAR WARRANTY

FOR MORE INFORMATION PLEASE VISIT WWW.BUSYBEETOOLS.COM

Metalworking Accessories



High Speed Steel End Mills
Weldon Shank
Multiple Flute, Single End

Model	Dia.	Shank	Length of Cut	Number of Flutes	Overall Length	Reg.	SALE
120305	1/8"	3/8"	3/8"	4	2 5/16"	\$ 6.99	\$ 4.99
120310	5/32"	3/8"	3/8"	4	2 5/16"	\$ 6.99	\$ 4.99
120315	3/16"	3/8"	3/8"	4	2 5/16"	\$ 6.99	\$ 4.99
120325	1/4"	3/8"	5/8"	4	2 7/16"	\$ 6.99	\$ 4.99
120335	5/16"	3/8"	5/16"	4	2 1/2"	\$ 6.99	\$ 4.99
120340	11/32"	3/8"	3/4"	4	2 1/2"	\$ 6.99	\$ 4.99
120345	3/8"	3/8"	3/4"	4	2 1/2"	\$ 6.99	\$ 4.99
120350	13/32"	3/8"	1"	4	2 11/16"	\$ 9.99	\$ 6.99
120355	7/16"	3/8"	1"	4	2 11/16"	\$ 9.99	\$ 6.99
120365	1/2"	3/8"	1"	4	2 11/16"	\$10.99	\$ 7.99
120370	1/2"	1/2"	1 1/4"	4	3 1/4"	\$11.99	\$ 8.99
120375	9/16"	1/2"	1 3/8"	4	3 3/8"	\$13.99	\$ 9.99
120380	5/8"	1/2"	1 3/8"	4	3 3/8"	\$14.99	\$10.99
120390	3/4"	1/2"	1 5/8"	4	3 5/8"	\$21.99	\$16.99
120400	7/8"	1/2"	1 7/8"	6	4"	\$26.99	\$20.99
120410	1"	1/2"	1 7/8"	4	4"	\$34.99	\$26.99

Center Drills



Plain type/right hand. H.S.S.

Model	Drill Dia.	Overall Length	Reg.	SALE
125280	3/64"	1 1/4"	\$1.99	\$1.29
125281	5/64"	1 7/8"	\$1.99	\$1.29
125282	7/64"	2"	\$2.99	\$1.69
125283	1/8"	2 1/8"	\$2.99	\$1.69
125284	3/16"	2 3/4"	\$5.99	\$3.49
125285	7/32"	3"	\$7.99	\$5.49

Woodruff Key Seat Cutter H.S.S.



1/2" diameter straight shank straight teeth

Model	A/S	Nominal Dia.	Width of Face	Reg.	SALE
125105	204	1/2"	1/16"	\$19.99	\$16.99
125130	406	3/4"	1/8"	\$19.99	\$16.99
125140	605	5/8"	3/16"	\$19.99	\$16.99

High Speed Steel Taps



Cut Clean Threads

Thread Size	Taper Model	Plug Model	Bottom Model	Reg.	SALE
4"-40NC		113022	113024	\$4.99	\$2.99
6"-32NC	113032	113034	113036	\$4.99	\$2.99
8"-32NC	113038	113040	113042	\$4.99	\$2.99
10"-24NC	113044	113046	113048	\$4.99	\$2.99
10"-32NF	113104	113106		\$4.99	\$2.99
1/4"-20NC	113116	113118	113120	\$4.99	\$2.99
1/4"-28NF	113200			\$4.99	\$2.99
5/16"-18NC	113122	113124		\$5.99	\$3.49

R8 End Mill Holders



For Weldon Shank End Mills
R8 tapers are threaded for 7/16"
draw bar; 20 TPI; Heat-treated steel.

Model	Hole Size	Reg.	SALE
B155	3/8"	\$21.99	\$17.99
B156	1/2"	\$21.99	\$17.99
B158	3/4"	\$24.99	\$20.99
B160	1"	\$26.99	\$23.99

High Speed Steel End Mills Weldon Shank



2 Flute, Single End

Model	Dia.	Shank	Length of Cut	Overall Length	Reg.	SALE
115105	1/8"	3/8"	3/8"	2 5/16"	\$ 6.99	\$ 4.99
115110	5/32"	3/8"	7/16"	2 5/16"	\$ 6.99	\$ 4.99
115115	3/16"	3/8"	7/16"	2 5/16"	\$ 6.99	\$ 4.99
115120	7/32"	3/8"	1/2"	2 5/16"	\$ 6.99	\$ 4.99
115125	1/4"	3/8"	1/2"	2 5/16"	\$ 6.99	\$ 4.99
115135	5/16"	3/8"	9/16"	2 5/16"	\$ 6.99	\$ 4.99
115145	3/8"	3/8"	9/16"	2 5/16"	\$ 6.99	\$ 4.99
115155	7/16"	3/8"	13/16"	2 1/2"	\$ 8.99	\$ 6.99
115165	1/2"	3/8"	13/16"	2 1/2"	\$ 9.99	\$ 7.99
115170	1/2"	1/2"	1"	3"	\$ 9.99	\$ 7.99
115180	5/8"	1/2"	1 1/8"	3 1/8"	\$15.99	\$10.99
115190	3/4"	1/2"	15/16"	3 5/16"	\$19.99	\$15.99
115200	7/8"	1/2"	1 1/2"	3 5/8"	\$24.99	\$19.99
115210	1"	1/2"	1 1/2"	3 5/8"	\$29.99	\$24.99

Precision Ground Tool Bits H.S.S.

Fine Quality high speed steel holds a keen edge for super results.



Model	Size	Reg.	SALE
160100	1/8" x 2 1/2"	\$ 2.69	\$1.99
160105	3/16" x 2 1/2"	\$ 2.69	\$1.99
160110	1/4" x 2 1/2"	\$ 2.69	\$1.99
160115	5/16" x 2 1/2"	\$ 4.29	\$2.99
160120	3/8" x 3"	\$ 5.99	\$4.50
B1021	3/8" x 1/2" x 4"	\$ 9.99	\$6.99
160130	1/2" x 4"	\$12.99	\$9.99

"Plain" Metal Slitting Saws H.S.S.



This High Speed Steel Slitting Saws is perfect for slitting thin wall tubing, sheets or screw heads. High Quality.

Model	Dia.	Width of Face	Hole Size	Teeth	Reg.	SALE
T747005	2"	1/16"	1/2"	28	\$15.99	\$ 9.99
T747010	2"	1/8"	1/2"	28	\$15.99	\$ 9.99
T747015	2 1/2"	1/32"	7/8"	28	\$16.99	\$10.99
T747025	2 1/2"	1/16"	7/8"	28	\$16.99	\$10.99
T747045	3"	1/32"	1"	30	\$17.99	\$11.99
T747055	3"	1/16"	1"	30	\$19.99	\$13.99
T747075	3"	1/8"	1"	30	\$21.99	\$15.99

Ball End Mills - Weldon Shank H.S.S.



- 2 flute/single end
- Right hand cut regular length

Model	Dia. Of Mill	Dia. of Shank	Length of Cut	Length	Reg.	SALE
T220005	1/8"	3/8"	3/8"	2 5/16"	\$18.99	\$15.99
T220010	3/16"	3/8"	1/2"	2 3/8"	\$18.99	\$15.99
T220015	1/4"	3/8"	5/8"	27/16"	\$19.99	\$16.99
T220025	3/8"	3/8"	3/4"	2 1/2"	\$19.99	\$16.99
T220035	1/2"	1/2"	1"	3"	\$27.99	\$19.99

Metalworking Accessories

Indexable End Mill 25mm MT3

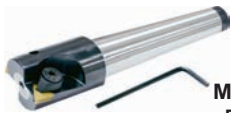

\$75

Model B3004
Reg. \$115.00

While Qtys. Last!

Comes with 2 carbide inserts.
Allen key included.

Optional Insert

Model B3004INS Reg. \$14.99 **\$12.99**

Welding Clamp



- Solid cast iron
1.6 kgs.
- Flat or round to
1 5/8"
- Acme screw
vise

\$21.99

Model B2309
Reg. \$27.99

Weight:
3.71 kg.

0-3/64" Pin Vise



\$2.99

Model B2911
Reg. \$3.99

Holds 0-3/64" small drill bits,
small files & round parts securely.

Steel Letters & Numbers Stamp Sets



B3735 &
B3745

Hardened
and heat
treated.

B3724

Model	Size	Reg.	SALE
B3724	1/8"	\$11.99	\$ 8.99
B3735	3/16"	\$14.99	\$12.99
B3745	1/4"	\$19.99	\$14.99

Square Lathe Chuck Keys

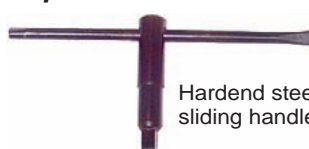

Hardend steel with
sliding handle.

Model	Size	Reg.	SALE
B1307014	1/4"	\$5.99	\$4.29
B1307516	5/16"	\$6.99	\$5.49
B1307038	3/8"	\$7.50	\$5.79

5/8" Shank Turning Tool



\$39.99

Model B2995
Reg. \$59.99
While Qtys. Last!

Designed for deep profile and for
general applications. Shank Size:
5/8", Length: 3-15/16". The tool
comes with a Torx key.

Optional Insert for B2995

Model B2995INS Reg. \$9.99 **\$7.99**

Mini Turning Tool Set, 4pc



\$85

Model B2996
Reg. \$165.00
While Qtys. Last!

These sets come in 4 different
shank sizes to choose from and
include 4 Indexable Carbide Inserts,
a Torx Key and Plastic Case.
Shank: 5/16"

Extra Insert

Model B2996INS Reg. \$9.99 **\$7.99**

Dovetail Cutter Cobalt M42



\$29.99

Model 125305COB
Reg. \$47.99
Weldon shank

- Overall length: 2 1/8"
- Angle: 45°
- Right hand cut: Regular
length
- Dia. of cutter: 1/2"; width:
5/32"

Dia. of
shank:
3/8"

new 4pc Turning Tool Set, Shank 12mm



\$125

Model B2998M
Reg. \$179.00

- This tool set covers a wide range
of turning applications
- Includes 4 (left hand and right
hand) turning tools, a Torx key.
Comes in a plastic case.

Precision Surface Plate



Black Granite

- Size: 12" x 18" x 3"
- Accuracy: + .0001"
- Weight: 35.6 kg.

\$42.99

Model
B1321
Reg.
\$54.99

Indicator Accessory Kit



- 4-48 thread
- 22 assorted
points that will fit
most indicators

\$6.29

Model B1965
Reg. \$7.99

"T" Hex Key Wrench 10pc Sets Inches



\$9.29

Model B904
Reg. \$11.99

- Includes sizes in inches:
3/32", 7/64", 1/8", 9/64", 5/32",
3/16", 7/32", 1/4", 5/16", 3/8"
- Metal Stand, specially selected
steels

MILESCRAFT Stubby Bits H.S.S.

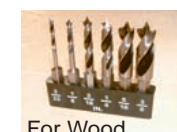

For Wood
2300



For Metal
2320 1/4"
Shank

Get into tight spaces!

Model	Qty.	Reg.	SALE
2300	6pc	\$23.99	\$20.99
2320	5pc	\$19.99	\$16.99

Metal Shims



\$14.99

Model
B1256

- Size: 1/2" x 3"
- 2 each of: 3/8"
1/4", 1/8", 1/16",
1/32"

American Pattern Files

Made from the finest grade steel specially finished by a method designed
to improve their cutting efficiency and lengthen their effective life.



Round Bastard

Mill Bastard

File Handle

Handy File

Model	Type	Reg.	SALE
B662RB1	10" Round Bastard	\$6.99	\$6.29
B662MB8	8" Mill Bastard	\$5.99	\$4.50
B662MB1	10" Mill Bastard	\$7.99	\$5.99
B661H5	File Handle For 8" Files	\$5.99	\$4.50
B661H6	File Handle For 10" Files	\$6.99	\$5.50
B1062	8" Handy File	\$8.99	\$5.99

Tap Handles



- High quality handles, finished in
black nitrate & knurled steel
- Jaw surfaces hardened

Model	Tap Size	Reg.	SALE
B368	0-3/8"	\$ 6.99	\$ 4.69
B369	3/16"-1/2"	\$ 6.99	\$ 4.69
B370	3/16"-3/4"	\$16.99	\$13.99

Double Ended Boring Bars



Made of hardened and tempered
tool-steel.

For tool bit size: 1/4" square
Length: B168 - 9"; B170 - 10"
B171 - 12"

Model	Shank Dia.	Reg.	SALE
B168	1/2"	\$ 7.50	\$ 5.99
B170	5/8"	\$14.99	\$12.99
B171	3/4"	\$16.99	\$13.99

R8 Morse Taper Sleeves



Precision drill sleeves to use
smaller MT tooling in larger R8 &
MT spindles. Hardened & ground
tool-steel.

Model	Taper Reduction	Reg.	SALE
B272	From R8 to MT3	\$14.99	\$10.99
B273	From R8 to MT2	\$14.99	\$10.99

Precision Live Centre MT3 Set



- 7 interchangeable
points
- Special taper
mount for quick
change of points

\$142.50

Model B231
Reg. \$159.00

Shop 24/7 @ busybeetools.com

Drill Presses & Accessories



Drill Presses

Our popular Drill Presses feature cast-iron construction, rack & pinion table raising, lever belt tension. Laser guide for CT022N. All chuck sizes: 5/8" 2 Year Warranty

Made In An
ISO9001 Factory

4" - 34"
RADIAL

\$425
Model
CT021N
Reg.
\$465.00



14"

\$475
Model
CT022N
Reg.
\$529.00



Model	Motor HP	Spindle	Table	Speed	Height	Weight
CT021N	1/2	JT33	4" - 34" 10" RD.	5	64"	65 kg.
CT022N	3/4	MT2	11 1/4" SQ.	12	64"	86 kg.

Econo Drill Chucks

Return the accuracy to your Drill Press!

Model	Size	Taper	Reg.	SALE
B045	1/2"	JT6	\$14.99	\$11.99
B046	1/8" - 5/8"	JT3	\$17.99	\$14.99



Drill Press Precision Vises

Model	Size	Reg.	SALE
B069	3"	\$14.99	\$11.50
B067	4"	\$17.99	\$14.50
B066	5"	\$29.99	\$23.99
B068	6"	\$35.99	\$28.50



Cast iron

Drill Bit Step 45 Degrees For Pocket Hole H.S.S.

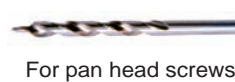

\$12.99
Model B1687
Reg. \$14.99

- 3/8" pocket hole and 1/8"
- Drill both holes at once

For pan head screws

Drill Chuck Arbors



R8
M.T.

Model	Taper	Reg.	SALE
For Draw Bar 3/8" x 16TPI			
B110D	MT2 - JT6	\$ 8.99	\$7.49
B111D	MT2-JT33	\$ 7.99	\$5.99
B116D	MT3-JT6	\$10.99	\$7.99

Model	Taper	Reg.	SALE
B107	MT2 - JT3	\$5.99	\$4.99
B110	MT2 - JT6	\$5.99	\$4.99
B111	MT2 - JT33	\$5.99	\$4.99
B113	MT3 - JT3	\$5.99	\$4.99
B116	MT3 - JT6	\$5.99	\$4.99
B117	MT3 - JT33	\$6.99	\$5.99
B119	R8 - JT3	\$9.99	\$8.29
B122	R8 - JT6	\$9.99	\$8.29
B123	MT1 - JT6	\$5.99	\$4.29



7pc Brad Bit Set

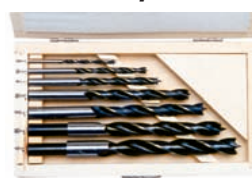

\$8.99
Model
B2452
Reg.
\$10.99

Alloy Steel

- Sizes: 1/8", 3/16", 1/4", 5/16", 3/8", 7/16" and 1/2"



Universal Drill Press Table



(Mortising Chisel, Clamp & Drill Press Not Included)

\$44.50
Model
B2660
Reg. \$57.99

- Comes complete with a 3" fence and a stop block both slide along the t-track slots
- Table size: 11 13/16" x 23" x 7/8"

Drill Stops 7pc Set



\$2.99
Model B734
Reg. \$3.49

- Sizes: 1/8", 3/16", 1/4", 5/16", 3/8", 7/16" and 1/2".

Deburring Tool Set



\$6.49
Model B254
Reg. \$7.99

- Extends 9"
- Comes with 3 blades

Mortising Attachment & Chisel Set



\$63.50
Model CT132
Reg. \$75.00

- To fit drill press quills 66mm & 60mm dia.



Quick Drill Press Hold Down



\$19.99
Model B2539
Reg. \$25.99

Fits most drill press tables with slots or holes.

- 5/8"D. column with 4 3/4" capacity and 3" throat
- Requires minimum 3/8" hole in table

Lathe Attachment For Drill Press



\$34.99
Model D4088
Reg. \$47.99

- Maximum Work-piece Capacity: 24" long
- Tool Rest: 12" long

7 pc Glass/Granite Drilling Set



\$47.50
Model D3839
Reg. \$59.99

- Ideal for mirror, non-tempered glass, tile, and granite countertop installations.
- Sizes: 3/16", 1/4", 5/16", 3/8", 1/2" and 3/4".

13pc Cobalt Drill Set



\$24.99
Model D2138
Reg. \$39.99

These bits turn faster without overheating.

- Sizes: 1/16" - 1/4" in 64ths
- Includes a steel index case.

25 Pc. TiN Coated Brad Point Bit Set H. S. S.

\$34.99
Model D2305
Reg. \$42.99

- Size: 1/8" - 1/2" By 64ths
- Steel index included



TITANIUM NITRIDE COATED

Precise Drill Chuck



\$45
Model B1998
Reg. \$54.99
Capacity: 1/2";
Taper: JT6
Key operated

Drill Press Tool Tray



(Equipment not included)

\$11.99
Model B1555
Reg. \$14.99

Quick access to tools then swings out of the way.

- Holds 13 drills 3/32" to 1/2"
- 11" diameter

Woodworking Machines & Accessories



12" Disc Sander

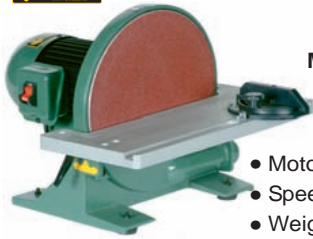

\$245

Model B2197
Reg. \$279.00

- Motor: 1 HP, 110V
- Speed: 1720 RPM
- Weight: 30 kg
- 2 Year Warranty

"Board Buddies", 2pc Sets



\$69.99

Model W1104
Reg. \$85.00

Turn only clockwise for table saws and routers. Prevents kick back. **YELLOW**

Optional Sliding Tracks

Model W1108 24" Long Reg. \$45.00 **\$37.99**



\$69.99

Model W1105
Reg. \$85.00

Turn in both directions - for shapers. **GREEN**



Post Level



\$2.49

Model B2605
Reg. \$3.49

Comes with rubber strap for mounting.

3pc Lathe Chisel Set, H.S.S.



\$79.99

Model D3782
Reg. \$99.00

Set includes: 5/16" Spindle Gouge; 1/8" Parting Tool; 1/2" Skew Chisel; A fitted Aluminum carrying case

12pc Chisel Set



\$84.99

Model D3784
Reg. \$115.00

Includes high carbon steel blades and ash handles measuring 8 3/4" long overall by 4 7/8" long. See website for more details.

8 Tray Sandpaper Storage Box

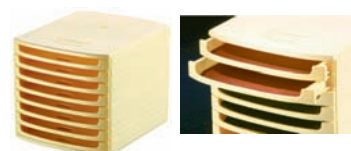

\$49.99

Model D2927
Reg. \$65.00

- 10" x 12" Tray
- Capacity: 50 Sheets

36" Saw Guide Rail



\$12.99

Model D3703
Reg. \$16.99

While Qts. Last!

Adjustable handles for easy positioning.

Provides a wide clamping surface for a variety of front & rear hold-down clamps.

8" Poly Jointer Knife Setting Jig



\$23.50

Model B3146
Reg. \$26.99

Easily and accurately set your jointer knives. Embedded magnets keep the jig in place on the jointer outfeed table & keep the steel knife from moving while you lock in into position.

10" Steel Sanding Disc For Table Saw



\$18.99

Model B1689
Reg. \$24.99

5/8" arbor hole

Your 10" table saw works like a disc sander with a big table for easy workplace feeding.

Extra Sanding 10" Discs - (3pc Set)
Sanding Discs Self Adhesive
Available, check on-line for details.



Sharpening Kit



\$89.99

Model DWSKITC
Reg. \$119.99

- Grade: Fine & Course Grit CC: 600 & 300 (nom. 25 & 50 micron) Grit TF3M: 600 (nom. 25 micron) Size (lapping fluid): 60ml Hazard type (lapping fluid): Harmful (Xn). DVD & booklet with hints & tips.



Block Plane



\$7.50

Model BP135
Reg. \$9.99

Base 6 1/2" long with a carbon steel cutter 1 1/2" wide.

Pop Up Bench Stop



\$6.99

Model B1541
Reg. \$8.99

- Just loosen the screw and it rises
- Use it opposite the vise with a vise dog

Template Guides



Template guides will fit Black & Decker, DeWalt, Freud, Hitachi, Porter Cable, Skil & any Router with a 1 3/16" centre hole.

Model	Outside	Inside	Guide Ht.	Reg.	SALE
B2427	5/8"	17/32"	9/16"	\$6.99	\$3.99
B2421IN	Template Guide Lock Nut)			\$3.99	\$2.99

"Cool Blocks" 4pc Set For Band Saws

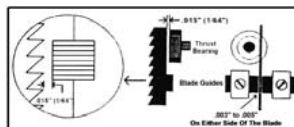

Increase the blade life & improve performance by using these graphite impregnated phenolic blocks.

Model	Size	Reg.	SALE
B2362	(4) 1/2" x 1/2" x 1 1/4"	\$19.99	\$17.99
B2363	(4) 1/2"D x 1 1/4"	\$19.99	\$17.99

Honing Tool (For H.S.S. Jointer Knives)



\$4.99

Model B1659
Reg. \$6.99

Hones: 180 -400 grit

Drawer Pull Jig



\$9.99

Model B2410
Reg. \$13.50

While Qts. Last!

Locate the centre line of the drawer, mark holes with an awl for exact location of screws, its that easy!

4 Jaw Safety Scroll Chuck



Model	Size	External Hold	Internal Hold	Reg.	SALE
B2249134	3/4" x 16 TPI	1 3/4" - 2 5/8"	2" - 3"	\$89.99	\$73.50
B2249108	1" x 8 TPI	1 3/4" - 2 5/8"	2" - 3"	\$89.99	\$73.50



12" Hacksaw Blade



\$1.49

Model B65912

24T H.S.S.

Shop 24/7 @ busybeetools.com

Dust Collection & Accessories



1 HP Portable Dust Collector

\$199

Model CT126
Reg. \$299.00



- Motor: 1 HP, 110V, 600 CFM
- Static Pressure: 8"
- Noise Level: 65 db
- Weight: 27 kg.
- Includes hose & dust collector arm attachment
- 5 Micron filter bag
- 3 Year Warranty

1 HP Dust Collector

\$225

Model CT053
Reg. \$275.00

Thousands Sold!

1 Micron Upper Bag



- Motor: 1 HP, 110V, 570 CFM
- Noise: 62 dB
- Weight: 30 kg.
- 3 Year Warranty



2 HP Dust Collector 1 Micron Upper Bag

\$369

Model CT186
Reg. \$425.00



- Motor: 2 HP, 1 Phase 220V
- Air Suction Capacity: 1790 CFM
- Impeller: 11"
- Weight: 47 Kg.
- 2 Year Warranty



1 HP Dust Collection Canister Drum for CT053

1 Micron

\$155

Model CT053CH
Reg. \$199.00



Upgrade your existing Dust Collector with a Canister for improved efficiency & better overall collection.



Mini Dust Cyclone Kit

\$59.99

Model B3069
Reg. \$65.00



Works with most shop vacuums.

Very Popular!

4pc Dust Accessories Kit

To service one machine



Model W1054	1+	3+
	\$27.99	\$23.79

Includes:
10' Hose,
1 Universal Hood,
2 Hose Clamps

17pc Dust Accessories Kit

To service two machines



Model W1055	1+	3+
	\$89.99	\$62.99

Includes:
2 Blast Gates
2 10' Hoses
1 Table Saw Hood
1 Universal Hood
1 "Y" Fitting
10 Hose Clamps

Dust Collection Basics Book

Very Popular!

\$7.99

Model W1050

50 Pages.

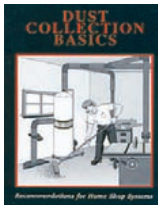

2pc Universal Shop Hook Set

Model B2987

1+ 3+

\$7.99 \$6.39



(Hose not included)

Made from high strength plastic, these hooks are very strong. Weight capacity of 15kg. per hook.



Industrial 5 HP Dust Collection System



\$1,799

Model CX409
Reg. \$1,999.00

- Motor: 5 HP, 220V
- 4820 CFM
- 13" impeller
- 4 - 4" openings
- Weight: 183 kg.
- 3 Year Warranty

Made In An
ISO9001 Factory

Made In Taiwan



Steel Strap Clamps



Model	Replacement Clamps	Reg.	SALE
CT036	For CT029(N) & B1140, 2pc	\$24.99	\$20.99
CT037	For CT030 & CT031 B404 & B405, 2pc	\$26.99	\$22.99
CT038	For CT031 & B405, 4pc	\$49.99	\$39.99

End Caps



Ideal for sealing openings on any 4" dust collection accessories such as elbows, y-connection, t-connections etc. Not designed for PVC hose.

Model	Description	Size	1+	3+
B2873	End Cap For Dust Collection	4"	\$1.69	\$1.35
B2874	End Cap For Dust Collection	5"	\$2.49	\$1.99

Dust Collection Accessories

Blast Gates

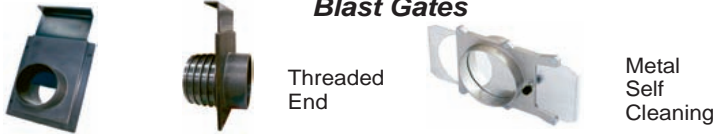

Model	Description	Size	1+	3+	10+
B2460B	Blast Gate - Plastic	2 1/2"	\$ 2.99	\$ 2.54	\$ 2.24
W1006	Blast Gate - Plastic	3"	\$ 3.99	\$ 3.39	\$ 2.99
W1007	Blast Gate - Plastic	4"	\$ 4.99	\$ 4.24	\$ 3.74
W1008	Blast Gate - Plastic	5"	\$ 7.99	\$ 6.79	\$ 5.99
B2905	Blast Gate - Threaded End	4"	\$ 5.99	\$ 5.09	\$ 4.49
B2957	Blast Gate - Metal Self Cleaning	2 1/2"	\$12.99	\$11.04	\$10.39
B2962	Blast Gate - Metal Self Cleaning	3"	\$11.99	\$11.39	\$10.79
B1015	Blast Gate - Aluminum	4"	\$14.99	\$11.99	\$11.24
B2906	Blast Gate - Self Cleaning	4"	\$ 5.99	\$ 5.09	\$ 4.49
B2955	Blast Gate - Metal Self Cleaning	4"	\$16.99	\$14.44	\$13.93
B2956	Blast Gate - Metal Self Cleaning	5"	\$19.99	\$16.99	\$16.39
B3049	Blast Gate - Metal Self Cleaning	6"	\$19.99	\$16.99	\$15.99

Clamps



Model	Description	Size	1+	3+	10+
B2980	Hose Clamp - Regular	2 1/2"	\$0.99	\$0.74	\$0.64
PH0025CW	Hose Clamp - Wire Type	2 1/2"	\$0.79	\$0.59	\$0.51
PH003CW	Hose Clamp - Wire Type	3"	\$0.79	\$0.59	\$0.51
PH004CW	Hose Clamp - Wire Type	4"	\$0.99	\$0.79	\$0.70
PH004CW10	Hose Clamp - Wire Type	4"	\$6.99	\$5.10	\$4.89
PH005CW	Hose Clamp - Wire Type	5"	\$1.49	\$1.11	\$0.96
W1319	Hose Clamp - Wire Type	6"	\$1.29	\$1.03	\$0.90
W1021	Hose Clamp - Gear Type	3"	\$1.19	\$0.89	\$0.77
PH004C	Hose Clamp - Gear Type	4"	\$1.49	\$1.26	\$1.11
PH005C	Hose Clamp - Gear Type	5"	\$1.99	\$1.59	\$1.39
PH003CK	Hose Clamp With Key	3"	\$2.25	\$1.80	\$1.57
PH004CK	Hose Clamp With Key	4"	\$2.25	\$1.80	\$1.57
PH005CK	Hose Clamp With Key	5"	\$2.25	\$1.80	\$1.57

Bags for Dust Collectors



Plastic Bottom Bags Set of 5



1 Micron Cloth Top Bag

Model	Description	Size	1+	3+	10+
CT032	Top Bag for 1HP Units	2 1/2"	\$24.99	\$21.24	\$18.74
CT033	Top Bag for 2HP & 3HP Units	3"	\$34.99	\$29.74	\$26.24
CT034	Plastic Bottom Bags for 1HP Units (5)	4"	\$15.99	\$12.79	\$11.51
CT035	Plastic Bottom Bags for 2HP & 3HP Units (5)	4"	\$20.99	\$16.79	\$15.11

Elbow Fittings



Model	Description	Size	1+	3+	10+
W1017	Elbow Fitting - Plastic	4"	\$7.99	\$6.39	\$5.59
B2460D	Elbow Fitting 45° Transparent	2 1/2"	\$1.49	\$1.22	\$1.11
B3052	Elbow Fitting 45°	2 1/2"	\$6.99	\$5.59	\$4.89
B2460G	Elbow 90° Transparent	2 1/2"	\$3.99	\$3.27	\$2.99
D4235	Elbow Fitting	2 1/2"	\$4.99	\$3.99	\$3.49
W1029	Elbow With Flange	4"	\$8.99	\$7.19	\$6.29

Cyclone Covers



Model	Description	Size	1+	3+	10+
B2407	Cyclone Cover Large	20 3/4"	\$34.99	\$29.91	\$26.59
B2408	Cyclone Cover Small	11 3/4"	\$18.99	\$16.14	\$14.33

Connectors & Couplers



Model	Description	Size	1+	3+	10+
B2460C	Pipe Coupling - Transparent	2 1/2"	\$1.49	\$1.22	\$1.11
B2907	Connector - Swivel	4"	\$7.99	\$6.39	\$5.59
B2460E	'T' Connector - Transparent	2 1/2"	\$3.99	\$3.27	\$2.99
B2696	Coupler	4"	\$4.99	\$3.99	\$3.49
W1036	Coupler - Threaded Taper	4"	\$4.99	\$3.99	\$3.49
D4236	Universal Adapter	2 3/4"	\$4.99	\$3.99	\$3.49
B2736	Adapter For Dust Collector	1" - 4"	\$3.99	\$3.59	\$3.19
B2554	Adapter For Dust Collector	6" - 1"	\$4.99	\$4.24	\$3.74
B2909	Quick Change Connector - Thread End	2 1/2" - 4"	\$3.99	\$3.19	\$2.79
D4249	Taper Adapter	4" - 2 1/4"	\$3.49	\$2.79	\$2.44
B2910	Quick Change Connector - Thread End	3" - 4"	\$3.99	\$3.19	\$2.78
B2500	'Y' Fitting Connector Plastic	4 - 2 1/2"	\$6.99	\$5.94	\$5.24
B2958	Splice Fitting	2 1/2"	\$1.99	\$1.59	\$1.39
W1019	Splice Fitting - Plastic	4"	\$5.99	\$4.79	\$4.19
B3107	Rubber Connector with Clamps	2 1/2"	\$7.99	\$6.79	\$6.39
B3106	Rubber Connector with Clamps	4"	\$9.99	\$8.49	\$7.99
B3202	Rubber Connector	4"	\$7.99	\$6.79	\$6.39

Flanges

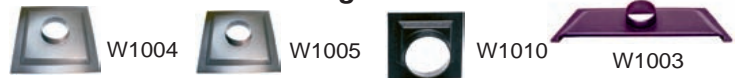

Model	Description	Size	1+	3+	10+
W1004	Flange Tablesaw Plastic 4"	12 1/4" x 12 1/4"	\$7.99	\$6.79	\$5.99
W1005	Flange Tablesaw Plastic 4"	14" x 14"	\$7.99	\$6.79	\$5.99
W1010	Flange Universal Plastic 4"	6 1/4" x 6 1/4"	\$2.99	\$2.39	\$2.09
W1003	Floor Sweep Plastic 4" For Dust Collector	21"	\$7.99	\$6.79	\$5.99

Shop 24/7 @ busybeetools.com

Dust Collection Accessories

'T' Fittings



Model	Size	1+	3+	10+
B3054	2 1/2"	\$ 5.99	\$ 4.79	\$4.19
W1013	4"	\$ 8.50	\$ 6.80	\$5.95
B2960	5"	\$11.99	\$10.19	\$8.99

'Y' Fittings

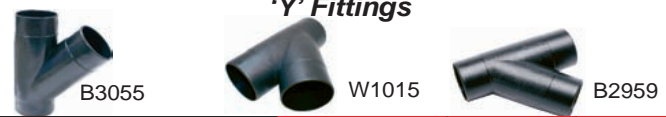

Model	Size	1+	3+	10+
B3055	2 1/2"	\$ 5.99	\$ 4.79	\$4.19
W1016	3"	\$ 6.50	\$ 5.33	\$4.68
W1015	4"	\$ 8.99	\$ 7.64	\$6.74
B2959	5"	\$11.99	\$10.19	\$8.99

Reducers

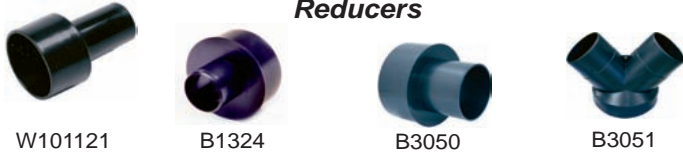

Model	Size	1+	3+	10+
W101121	2 1/2" - 1 1/2"	\$1.69	\$1.38	\$1.18
W10113212	3" - 2 1/2"	\$1.99	\$1.59	\$1.39
W101132	3" - 2"	\$1.99	\$1.59	\$1.39
B1324	4" - 2"	\$3.49	\$2.96	\$2.61
W1011	4" - 3"	\$2.99	\$2.39	\$2.09
W1044	4" - 2 1/2"	\$2.49	\$2.11	\$1.99
B2961	5" - 4"	\$4.99	\$3.99	\$3.59
B3050	6" - 4"	\$7.99	\$6.79	\$5.99
B3051	6" - Two 4"	\$8.99	\$7.19	\$6.29

Dust Hoods



Model	Description	Size	1+	3+	10+
B2501	Dust Hood For Router Table	2 1/2"	\$ 6.99	\$ 5.94	\$ 5.24
W1002	Dust Hood For Jointer Plastic	8 1/2" x 10 1/4"	\$ 4.99	\$ 3.99	\$ 3.49
W1001	Dust Hood For Jointer Plastic	8 1/4" x 8 1/4"	\$ 3.99	\$ 2.99	\$ 2.59
B2502	Dust Hood	10" X 4"	\$ 5.99	\$ 4.97	\$ 4.49
B2499	Dust Hood Big Gulp Plastic	12" x 16"	\$15.99	\$11.99	\$10.87
B2834A	Dust Hood For Hold Tite B2834	2 1/2"	\$ 2.99	\$ 2.09	\$ 1.85
B2834B	Dust Nozzle For B2834	2 1/2"	\$ 2.99	\$ 2.09	\$ 1.85
B064	Dust Port	4"	\$ 2.99	\$ 2.24	\$ 1.94
W1042	Dust Port For 3 Hole O/D	2 1/2"	\$ 2.99	\$ 2.24	\$ 1.94
D4237	Router Dust Port	2 1/2"	\$ 3.49	\$ 2.79	\$ 2.44

Hoses

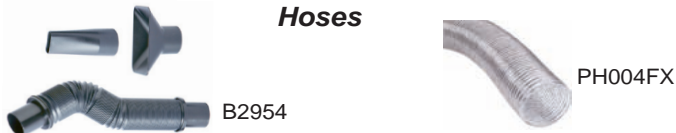

Model	Description	Size	1+	3+	10+
B2954	Hold Tite Hose Kit	2 1/2"	\$16.99	\$13.59	\$11.89
B3048	Hold Tite Hose Kit	4"	\$24.99	\$19.49	\$17.99
B2834	Hold Tite Hose, 3ft. Length	2 1/2"	\$12.99	\$ 9.74	\$ 9.09
PH0025FX	Super Flex PVC Hose Clear, 10ft. Roll	2 1/2"	\$24.99	\$21.24	\$17.99
PH004FX	Super Flex PVC Hose Clear, 10ft. Roll	4"	\$29.99	\$25.49	\$21.59

Model	Description	Size	1+	3+	10+
*PH00610	PVC Hose Grey, 10ft. Roll	6"	\$65.00	\$58.50	\$52.00
*PH00425	PVC Hose Grey, 25ft. Roll	4"	\$62.50	\$56.25	\$50.00

* Call Or Inquire For Bulk Pricing (1-800-461-2879)

Hoses



Model	Description	Size	Per Foot	50 Foot Roll
PH0025	Hose PVC Clear	2 1/2"	\$2.25	\$107.50
PH0025G	Hose PVC Grey	2 1/2"	\$1.99	\$ 89.50
PH003	Hose PVC	3"	\$2.35	\$115.00
PH004	Hose PVC	4"	\$2.59	\$125.00
PH005	Hose PVC	5"	\$4.39	\$199.00
PH003CL	Hose PVC Clear	3"	\$2.59	\$119.50
PH004CL	Hose PVC Clear	4"	\$3.15	\$149.50
PH005CL	Hose PVC Clear	5"	\$4.99	\$234.50

Miscellaneous



Model	Description	1+	3+	10+
B2912	Dust Master Shop Kit	\$ 64.99	\$ 55.24	\$ 51.99
B2460	2 1/2" Dust Collection Kit Clear	\$165.00	\$148.50	\$132.00
B2875	4" Dust Collection Kit with Clear Piping	\$149.00	\$111.75	\$101.32
B2494	Lathe Dust Hood with Track - 36"	\$ 69.99	\$ 59.49	\$ 55.99

Model	Description	Size	1+	3+	10+
B2968	Mounting Bracket for Blast Gate	2pc	\$ 9.99	\$ 8.69	\$ 7.79
B2691	Hose Clamps 5pc For Wall	4"	\$ 5.99	\$ 3.89	\$ 3.59
B2834C	Connector For B2834 Hold Tite	2 1/2"	\$ 2.99	\$ 2.09	\$ 1.85
B2460A	Tubing - Clear	2 1/2" x 3ft.	\$ 9.99	\$ 8.19	\$ 7.49
W1053	Grounding Kit For Dust Collection		\$16.99	\$14.78	\$13.08



Kreg Tools



The best selling Kreg Jig incorporating the best features with an all-new clamping mechanism.

Includes:

- Drill Guides: 3
- Drill Guide Spacing: 9/16", 7/8", 1-7/16"
- Clamping Method: Ratcheting Clamp on Benchtop Base, Front-side Mounted Handle

Pocket Hole Jig System



\$173.95
Model K5

Jig Master System K4

The best selling Kreg Jig, this kit has everything you need to get started. Complete with jig, clamps, step drills, blow molded carry care and instructional guide.

\$173.95
Model K4MS



Watch the video @ busybeetools.com

Feather Board Twin Pack



Reg. \$46.25 **\$38.99**
Model PRS3020
Designed with each finger of the True-FLEXO feather-board to provide a consistent and optimum pressure.

Jig Master System



\$123.95
Model K4

This System is the ultimate Pocket-Hole Jig on the market, and a great choice for any woodworking enthusiast.

R3 Jig Kit



\$49.95
Model R3

Watch the video @ busybeetools.com

The Kit Includes:

- Kreg Jig Jr., Clamp Pad Adapter, Stepped Drill Bit, 6" Driver Bit, Depth Collar, Allen Wrench, Starter Screw Set all in a durable compact carry case.

3" Automaxx Face Clamp



\$29.99
Model KHC1410
Reg. \$37.49

- Hand held clamping with Automaxx™ Auto Adjust technology
- Thickness Capacity: Up to 2 7/8"

6" Automaxx Face Clamp



\$39.99
Model KHC1420
Reg. \$47.49

Auto Adjust technology automatically adjusts to any thickness up to 4-1/4". Compatible with Kreg Jig, Kreg Portable Base and Kreg Jig.

Right Angle Clamp



\$29.99
Model KHCRCAC
Reg. \$39.99

- Great for assembling all types of box joints
- 90° clamping made easy

Large Face Clamp



\$29.99
Model KHCLARGE
Reg. \$39.99

- 6" reach ensures perfectly flush joint lines
- Use with pocket-hole systems

Mini Jig Kit



\$24.95
Model MKJKIT

It features no-fence design that allows for easy positioning in practically any location.

Replacement Twist Step Drill Bit for Manual-Pocket Hole Systems



\$16.99
Model KJD
Reg. \$21.99

- Drill bit for use with pocket hole joinery

Jig Hd Pocket Hole for 1 1/2" Material



\$73.95
Model KJHD

Bigger bit, holes, screws, & of course larger projects!

Crown Pro



\$29.99
Model KMA2800
Reg. \$34.99

Holds your trim at the exact angle required, eliminating the need for advanced compound miter cuts.

Square Bit Driver Combo 2 x 6" No. 2



\$5.69
Model D6X2
Reg. \$6.85

- Size: 2" x 6"
- #2 Square driver

Rip Cut



\$34.99
Model KMA2675
Reg. \$43.75

Made for your circular saw. Features a solid aluminum guide rail, an easy-to-read adjustable scale, and a reversible guide arm.

Shelf Pin Jig



\$34.99
Model KMA3200
Reg. \$43.75

Includes Shelf-Pin Jig, locating pin, jig extender, 1/4" drill bit, depth collar, Allen wrench, instruction manual, and four 1/4" shelf pins.

5mm Shelf Pin Jig



\$34.99
Model KMA3220
Reg. \$43.75

Features hardened steel drill guides which ensure precise, straight drilling and a dual position adjustable fence for custom hole placement.

Multi Mark

\$14.99
Model KMA2900
Reg. \$18.75

This tool works as: 3-Way Adjustable Rule, Imperial & Metric Scale. Compact Design, Layout Tool, Trimming Tool, T-Square, Depth Gauge, Torpedo Level & Story Stick.

Pocket Hole Screw Kit, in 5 Sizes



\$29.99
Model SK03
Reg. \$39.99

Check On-Line busybeetools.com For Sizes

This screw kit is consist of 5 popular screw sizes for pocket hole joinery. All comes in a durable easy-to-carry case.

Deck Jig



\$98.95
Model KJDECKSYS

The kit includes Kreg Deck Jig, specialized drill bit, driver bit, two stop collars and six deck spacers. As an added value, each Deck Jig includes an instructional DVD to get you started right away.

- Unit Height: 9.50"
- Unit Width: 12"
- Unit Depth: 4"
- Weight: 4 lbs

Shop 24/7 @ busybeetools.com

Adhesives & Finishes



Gorilla Glue "The Toughest Glue on Planet Earth"



100% Waterproof

Model	Size	1+	3+
50002	2 Fl.oz	\$6.99	\$6.15
50004	4 Fl.oz	\$9.99	\$9.19



Polyurethane Glue



- Ideal for wood, metals, ceramics, most plastic, HPL stone & more
- 100% waterproof!

Model	Size	1+	3+
B2218	5 oz.	\$11.99	\$10.79
B2219	8 oz.	\$14.29	\$12.85
B1112	12 oz.	\$20.99	\$18.70



Premium Wood Glue

- Ideal for woodworking projects, including outdoor furniture
- Non-toxic

* B2226 Available in store only

Model	Size	1+	3+
B2223	8 oz.	\$ 6.99	\$ 5.94
B2224	16 oz.	\$ 9.99	\$ 8.81
B2225	Quart	\$14.99	\$13.32
* B2226	1 Gallon	\$39.50	\$36.10



Ultimate Wood Glue



Water proof. For interior & exterior use.

Model	Size	1+	3+
B2512	4 oz.	\$ 5.99	\$ 5.40
B2513	8 oz.	\$ 8.50	\$ 7.58
B2514	16 oz.	\$15.99	\$14.40
B2515	32 oz.	\$19.99	\$17.99



Ultimate Wood Glue, 1 Gallon



Model B2516	1+	3+
	\$55.99	\$53.19

Available in store only

Titebond III is non-toxic, solvent free and cleans up with water. Safer to use than traditional waterproof wood glues.



Original Wood Glue



Ideal for wood, hardboards, particle boards, leather, cloth etc....

Model	Size	1+	3+
B2220	16 oz.	\$ 8.50	\$ 7.70
B2221	Quart	\$10.99	\$ 9.89
* B2222	1 Gallon	\$27.99	\$25.20

* B2222 Available in store only



Melamine Glue



Bonds wood, MDF, Melamine, Vinyl, HPL as well as Metals.

Model	Size	1+	3+
B2914	16 oz.	\$13.99	\$12.34
* B2915	1 Gl.	\$56.50	\$49.72

* B2915 Available in store only



Wood Moulding Glue



The thickest, fastest-drying glue available for use with porous and semi-porous materials.

Model	Size	1+	3+
B3137	8oz.	\$7.50	\$6.00
B3138	16 oz.	\$9.99	\$8.49

Glue Roller Bottle



\$5.49

Model B988
Reg. \$6.99

- Save hours of spreading messy glue. Excess glue will not stick to the roller or the bottle

Powerful Grip Double Sided Tape



Ultimate grip strength.

Model B3170	1+	3+
	\$7.99	\$4.99



Liquid Hide Glue



Model B2348	1+	3+
	\$9.99	\$8.97

8 oz. squeeze bottle

- May be used for crackle effect
- Ideal for furniture repair

Clapham's Salad Bowl Finish



For salad bowls & butcher's block seals & preserves.

Model	Size	Reg.	SALE
B158902	1.75 oz.	\$ 9.99	\$ 7.99
B158909	8 oz.	\$21.99	\$19.99

Clapham's Beeswax Polish



All natural. Polishes & seals fine wood.

Model	Size	Reg.	SALE
B152702	1.75 oz.	\$ 9.99	\$ 7.99
B152709	7 oz.	\$21.99	\$19.99

5pc Glue Syringe Set



Great Value Buy!

These disposable glue syringes help pin point glue exactly where you want, whether it is biscuit slots, dowel holes or any gluing project. Accurately insert glue where it is needed.

Model B2991	1+	3+
	\$4.99	\$3.99

Silicone-Free Sliding Compound



Model B2917	1+	3+
	\$16.99	\$14.44

- Cast iron table sealant works amazing & out performs paste wax
- No CFC's
- Used as sealant on wood, metal and plastic
- Size: 1 Qt.

Woodworker's Tool Lube



Model B2918	1+	3+
	\$15.99	\$13.59

- Cast iron table sealant & cutting blade lubricant reduces friction significantly
- Repels moisture and dirt and prevents rust
- Size: 12 oz



Instant Nails Glue

Model B3171	1+	3+
	\$6.99	\$5.59

Used to fix skirting boards dados, rails, door surrounds, wall paned etc...Size: 310ml





PERSONALIZED SERVICE Mon - Fri 8:30am - 5:00pm ET Saturday 8:30am - 4:00pm ET

NO HASSLE RETURN POLICY:

If for whatever reason you are not satisfied, just return your purchase, postage prepaid or in store with your original receipt within 30 days from the date of purchase.

busybeetools.com

Call Toll Free - 24 Hours For
Placing Orders Only
1-800-461-BUSY (2879)
FAX: (905) 738-9143

Exempt items from return policy. Consumables, sandpaper, blades, router bits & shaper cutters books, magazines, DVD's & special orders, discontinued & inactive items. For more information visit www.busybeetools.com

PLEASE USE THE ORDER FORM TO LIST ALL NECESSARY DATA BEFORE CALLING

MAIL: 130 Great Gulf Drive, Concord, Ontario, L4K 5W1

Cut On Dotted Line

ERRORS & OMISSIONS EXCEPTED

Name <i>Please print clearly</i>		Customer #	Date
Address			City
Province		Postal Code	Telephone Number ()

In the event of a postal service disruption, we will strive to send your parcel by alternate means at no additional cost to you.

* Shipments under 30 kg. are sent by Canada Post. Shipments over 30 kg., please call for special shipping charges.

Your privacy is protected at Busy Bee Tools. We do not give or share our mailing list with anyone.

Credit Card Money Order

--	--	--	--	--	--	--	--	--	--	--	--

Signature _____ Expiry Date

--	--	--	--

ITEM TOTAL

Shipping & Handling
Under \$50.00 = \$ 9.99
\$51.00 - \$120.00 = \$12.99
Over \$120.00 = \$14.99
Excluding Oversize Items
Except Air Stage Area
(One Parcel Under 30 kg./66 lbs.)

Sub Total

B.C. - 5% GST, 8% PST
N.S. - 15% HST; P.E.I. - 14% HST
Ont., N.B. NFLD. - 13% HST
P.Q., AB., SK., MB. - 5% GST

GRAND TOTAL

Summer 2015 Catalogue, Sale Expires August 8th, 2015

Pedal Exerciser w/Digital Display



\$29.99
Model B3303
Reg. \$49.99

Special Buy

Exercise your arms or legs while watching TV!

- With the LCD display you can measure the length of each exercise session, the amount of calories you have burned as well as the amount of reps.

Choicemed Finger Pulse Oximeter



\$39.99
Model B3304
Reg. \$69.99

Special Buy

- Spot check heartbeat and blood oxygen level instantly

650pc Assorted Cable Ties



\$11.99
Model B3301
Reg. \$14.99

- Assorted colours
- Multipurpose
- Size: 4", 8" & 11" ties

Folding Step Stool



\$11.99
Model B3300
Reg. \$14.99

- Easy to carry, folds flat for space saving storage
- Durable construction
- Size: 13"W x 11.5" D x 12-3/4"H

Seal Here With Tape. No Glue Please.

Third Fold Here



From: _____



1000065483-L4K5W1-BR01



BUSY BEE MACHINE TOOLS
130 GREAT GULF DR
CONCORD ON L4K 9Z9



Second Fold Here



HEAD OFFICE
CONCORD ONTARIO



130 Great Gulf Drive
Concord, Ontario, L4K 5W1
TEL: (905) 738-5115
FAX: (905) 738-9143

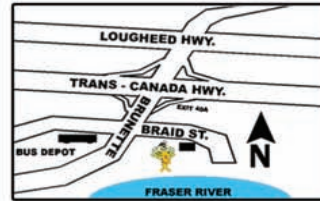

30 Braid Street
New Westminster, B.C., V3L 3P3
Tel: (604) 517-3922
Fax: (604) 517-8272



2895 Argenta Road
Mississauga, Ontario, L5N 8G6
Tel: (905) 812-3202
Fax: (905) 812-3206

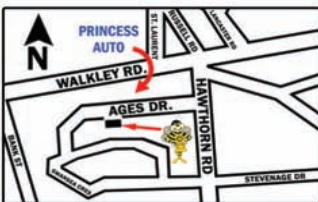

1400 Ages Drive
Ottawa, Ontario, K1G 5T4
Tel: (613) 526-4696
Fax: (613) 523-6885

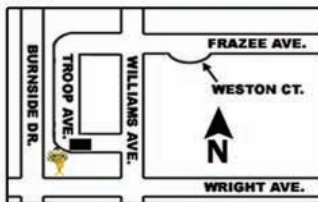

86 Troop Avenue
Dartmouth, Nova Scotia, B3B 1Z1
Tel: (902) 468-8088
Fax: (902) 468-8830

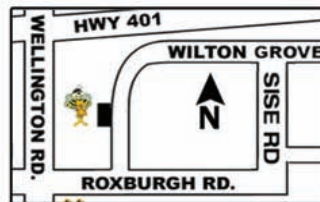

1398 Wellington Road (enter Wilton Grove)
London, Ontario, N6E 3N8
Tel: (519) 659-9868
Fax: (519) 659-0771

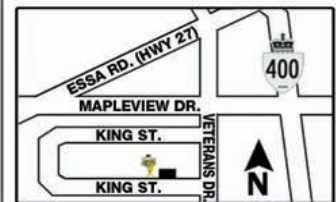

351 King Street Unit 8-10
Barrie, Ontario, L4N 6B5
Tel: (705) 730-0498
Fax: (705) 730-0495

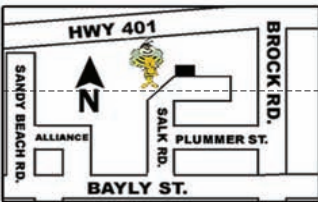

1064 Salk Road
Pickering, Ontario, L1W 4B5
Tel: (905) 831-9582
Fax: (905) 831-4292

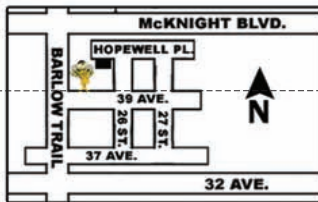

Unit 109, 2611 Hopewell Place N.E.
Calgary, Alberta, T1Y 7K3
Tel: (403) 250-1986
Fax: (403) 250-7768

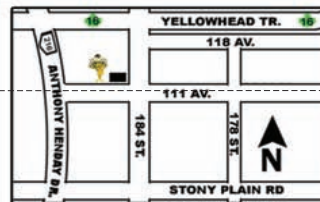

18520 - 111 Avenue, N.W.
Edmonton, Alberta, T5S 2V4
Tel: (780) 487-1202
Fax: (780) 487-1255

STORE HOURS

Mon - Fri 8:30 am - 5:00 pm
Saturday 8:30 am - 4:00 pm

Ottawa & London Stores

Mon - Wed 8:30 am - 5:00 pm
Thur - Fri 8:30 am - 7:00 pm
Saturday 8:30 am - 4:00 pm

Seal Here With Tape. No Glue Please.

First Fold Here

Seal Here With Tape. No Glue Please.

First Fold Here

18 Flat Rate Shipping Up To 30kg. Most Orders Shipped Within 24 Hours!

CLEARANCE SECTION

HURRY - THESE OFFERS ARE STRICTLY LIMITED!



CRAFTEX **2 Wheel Hand Truck**

- Toe Plate: 9" x 14"
- 600 lbs. Capacity
- Two 10" Wheels
- Made of Heavy Duty Steel
- Items can be Stacked up to 49" High
- Loop "P" Handle-Designed for One Handed Operation

\$21⁹⁹ Each

Pneumatic Wheels B3180 - Reg. \$45
Solid Wheels B3180A - Reg. \$47.50



CRAFTEX **Folding Platform Truck**

- Durable Steel Construction
- Large 19" x 29" Deck Size
- Non-Slip Deck Surface
- Max. Capacity: 330 lbs
- Folds For Easy, Compact Storage

\$24⁹⁹

B3179 - Reg. \$49.99



MILESCRAFT **WheelEzze**

The industry's safe wheel-dressing tool

For cleaning, dressing and truing grinding wheels.

\$4⁹⁹

2500 - Reg. \$11.99



IRWIN Industrial Tools **3pc Chisel Set**

This set is made with high quality hardened steel blades for superior performance and edge retention. Slim, contoured handles provide added control, precision and comfort. Design for use with a wooden mallet or the palm of the hand.

- Size: 1/2", 3/4" and 1"

\$12⁹⁹

1769179 - Reg. \$35.99



IRWIN Industrial Tools **27pc Drill Drive Set**

This set includes (3) No.2 square recess 1 IN insert bits and (4) No.2 Phillips 1 IN insert bits. 7 of the most common TORX bits, plus a compact magnetic screw guide and No.2 Phillips 8/10 slotted double-end bit

\$14⁹⁹

1800580 - Reg. \$29.99

OSCILLATING SPINDLE SANDER SLEEVES

All B1970 Sanding Sleeves priced to clear!



MT3 Arbor for Drill Chuck

- Arbor for CT129
- Size: 3/8"

\$3⁹⁹

CT129NARBOR - Reg. \$11.99



Dowel Bit

- 0.24" x 6mm -TCDWL6 - Reg. \$9.99
- 0.31" x 8mm -TCDWL8 - Reg. \$9.99
- 0.39" x 10mm -TCDWL10 - Reg. \$9.99

\$2⁹⁹ Each



2pc Euro Hinge

- 35mm Cup size
- 110°

\$4⁵⁰ Each

B13452 - Reg. \$8.99



1" x 10Ft. Rubber Silicone Tape

Miracle Wrap is a self-fusing silicone wrap, made out of specially formulated silicone rubber. An all purpose repair tape, this tape has a no adhesive but chemically bonds to itself upon contact. Simply wrap it and you have an airtight waterproof seal. • 20 MIL

- Black - B3076B - Reg. \$6.99
- Red - B3076R - Reg. \$6.99
- Yellow - B3076Y - Reg. \$6.99

\$3⁹⁹ Each



Narrow Crown Stapler - 18 Gauge

- Touch Strike security
- Shoots staples from 13/32" - 1"
- Capacity: 100pcs
- Required Pressure: 60 - 100 psi

\$24⁹⁹

CT114 - Reg. \$49.99



3 In 1 Flooring Nailer - 16 Gauge

- Capacity: 100 pc
- Required Pressure: 70 - 115 psi
- Max Pressure: 120 psi
- Pneumatic, Single Strike Design
- Mallet Included

\$11⁹

CT182 - Reg. \$249

While Quantities Last - May not be available at all branches - Call to confirm stock

Shop Essentials

50" Slip Roll, 16 Gauge Capacity

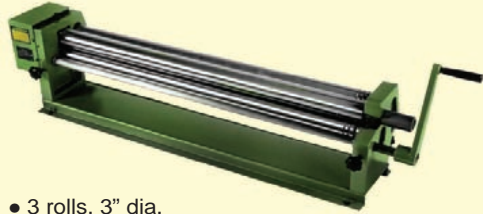

- 3 rolls, 3" dia. steel
- 3 wire grooves: 1/4", 3/8" & 1/2"
- Gross weight: 260 kg.
- 2 Year Warranty

\$1,099
Model B90850
 Reg. \$1,299.00
 While Qtys. Last!

Optional Stand While Qtys. Last!
Model B90850ST Reg. \$299.00 **\$265.00**

16pc Forstner Bit Set



new

\$89.99
Model D2720
 Reg. \$115.00

While Qtys. Last!

TITANIUM NITRIDE COATED

- Sets include: 1/4", 3/8", 1/2", 5/8", 3/4", 7/8", 1", 1-1/8", 1-1/4", 1-3/8", 1-1/2", 1-5/8", 1-3/4", 1-7/8", 2" and 2-1/8".
- The 1-1/8" and larger bits feature saw-tooth edges for aggressive boring action. Feature hex shanks for no-slip gripping in 3/8" and larger drill chucks

12pc Spring Clamp Set



\$12.99
Model D4129
 Reg. \$19.99

While Qtys. Last!

These spring clamps are unbeatable for securing glue joints, clamping jigs, holding down tarps, or hundreds of other shop chores that require an "extra hand". Non-marring jaws pivot to increase their grip on uneven surfaces. Includes four each of 1", 2" and 3" spring clamps.



Track Saw Master Pack

\$329

Model W1832
 Reg. \$399.00
 While Qtys. Last!



A powerful 1HP motor & plunge-cutting action eliminating flip-up blade guards. This combo kit includes the full length 55" rails & accessory clamp pack for making straight cuts when cutting wide panels.

Optional 28" Guide Rail While Qtys. Last!
Model D4445 Reg. \$49.99 **\$29.99**



1/2" Impact Wrench Twin Hammer

\$69.99

Model TL140200
 Reg. \$139.00
 While Qtys. Last!



- 8500 RPM
- Lightweight at 5.2 pounds
- Ideal for automotive maintenance and repairs
- Easy to adjust with torque regulator
- Max torque output of 450-Foot Pound.



Flashlight 18V Led (Tool Only)

\$45

Model DML801
 Reg. \$89.99

While Qtys. Last!



- Rotatable (left or right) and foldable head design
- Full Brightness: Approx. 9 Hours (with Battery BL1830)
- Half Brightness: Approx. 22 Hours (with Battery BL1830)

Assorted Pocket Screws



All Threads are: #8 COARSE

Model	Size	Qty.	Reg.	SALE
SMLC1100	1"	100	\$ 5.99	\$ 4.69
SMLC125100	1 1/4"	100	\$ 6.29	\$ 4.99
SMLC1251000	1 1/4"	1000	\$34.99	\$29.99
SMLC125500	1 1/4" w/Washer Head	500	\$23.59	\$19.99
SMLC150100	1 1/2"	100	\$ 6.49	\$ 4.99
SMLC150500	1 1/2"	500	\$26.25	\$19.99
SMLC2250	2"	250	\$18.36	\$14.99
SMLC250	2"	50	\$ 4.59	\$ 3.99
SMLC250250	2 1/2"	250	\$23.59	\$18.99
SMLC25050	2 1/2"	50	\$ 6.99	\$ 5.29
SMLC250B50	2 1/2"	50	\$ 7.25	\$ 5.99
SMLC250B250	2 1/2" BLUE-KOTE	250	\$26.25	\$19.99

Model	Size	Threads	Qty.	Reg.	SALE
SMLF125100	1 1/4"	#7 FINE	100	\$ 5.86	\$ 4.59
SMLF1251000	1 1/4"	#7 FINE	1000	\$34.99	\$29.99
SMLF125500	1 1/4"	#7 FINE	500	\$25.86	\$19.50
SMLF150100	1 1/2"	#7 FINE	100	\$ 6.49	\$ 4.99
SMLF150500	1 1/2"	#7 FINE	500	\$26.25	\$20.99
SMLF1501000	1 1/2"	#7 FINE	1000	\$39.35	\$30.99
SPSC1100	1" Pan Head	#7 COARSE	100	\$ 5.59	\$ 4.29
SPSF075100	3/4" Pan Head	#6 FINE	100	\$ 5.59	\$ 4.29
SPSF1100	1" Pan Head	#6 FINE	100	\$ 5.99	\$ 4.50



INDUSTRIAL STRENGTH ROUTER BITS

- ▶ C3 INDUSTRIAL MICROGRAIN CARBIDE
- ▶ LIMITED LIFETIME WARRANTY

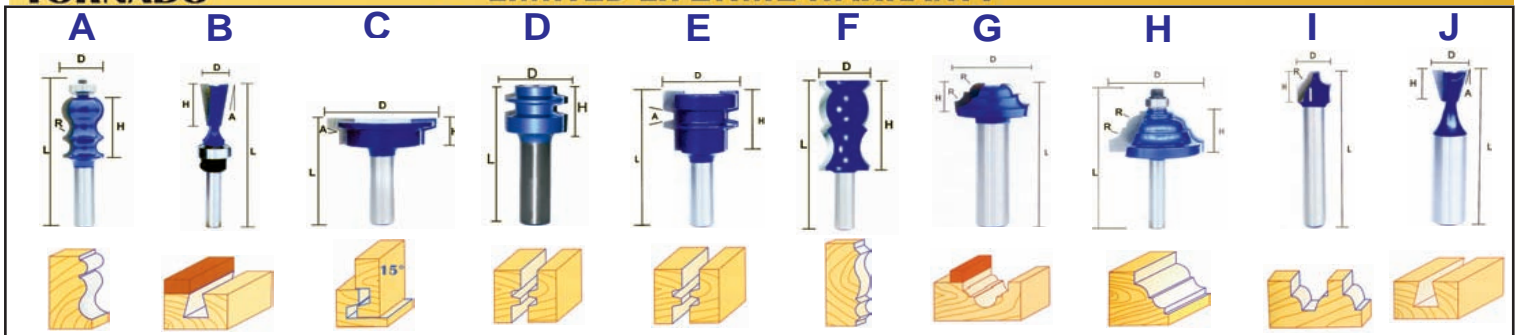

Face Molding Bit

Image A

Enhance furniture or door casings with these heavy duty bits.

Model	Cutting Dia. (D)	Cutting Length (H)	Radius	Overall Length (L)	Shank	PRICE
767240C	15/16"	1 7/16"	11/32"	3 9/16"	1/2"	\$33.99

Crown Molding Bit

Image F

Beautiful crown moldings for your home and furniture projects never looked so good than with these razor sharp bits.

Model	Cutting Dia. (D)	Cutting Length (H)	Overall Length (L)	Shank	PRICE
777286A	1 1/8"	2 1/4"	4"	1/2"	\$40.99

Dovetail Bit with Top Bearing

Image B

Use this bit for intricate dovetail joints, jewelry boxes, glue joints for drawers, shadow boxes and shaker furniture.

Model	Cutting Dia. (D)	Cutting Length (H)	Angle (A)	Overall Length (L)	Shank	PRICE
*105127D	1/2"	15/32"	14°	2 7/16"	1/4"	\$6.99

Plunge Classical Bit

Image G

Create decorative edge profiles, perfect for enhancing doors and drawer fronts.

Model	Cutting Dia. (D)	Cutting Length (H)	Radius	Overall Length (L)	Shank	PRICE
5551901	3/4"	15/32"	3/32"	1 3/16"	1/4"	\$13.99

Drawer Lock Bit

Image C

Gives very strong joint between drawer side and drawer front. Use only with Router Table.

Model	Cutting Dia. (D)	Cutting Length (H)	Angle (A)	Overall Length (L)	Shank	PRICE
807508C	2"	1/2"	15°	2 1/8"	1/2"	\$39.99

Classical Bits & Bead w/Bearing Guide

Image H

Very versatile bit. Creates decorative moldings on furniture and building applications.
Bearing Diameter - 527350: 1/2" 537350: 3/8"

Model	Cutting Dia. (D)	Cutting Length (H)	Radius	Overall Length (L)	Shank	PRICE
527350	1 3/8"	5/8"	3/16"	2 3/4"	1/2"	\$19.99
537350	1 3/8"	5/8"	3/16"	2 3/4"	1/2"	\$19.99

Reversible Glue Joint Bit

Image D

This bit is used to join stock to make wide panels. Align the bit to center & reverse each board for the perfect glue joint. For use with router table.

Model	Cutting Dia. (D)	Cutting Length (H)	Angle (A)	Overall Length (L)	Shank	PRICE
797270E	1 1/16"	3/4"		2 1/4"	1/2"	\$35.99

Beading Bit Plunge

Image I

For use in manufacture of furniture such as "French Provincial" decorative grooves in molding.

Model	Cutting Dia. (D)	Cutting Length (H)	Radius	Overall Length (L)	Shank	PRICE
625095	3/8"	3/8"	1/8"	1 3/4"	1/4"	\$8.99

Reversible Glue Joint Bit

Image E

This bit is used to join stock to make wide panels. Align the bit to center and reverse each board for the perfect glue joint. For use with router table.

Model	Cutting Dia. (D)	Cutting Length (H)	Angle (A)	Overall Length (L)	Shank	PRICE
797381C	1 1/2"	1 1/4"	30°	2 7/8"	1/2"	\$40.99

Dovetail Bits

Image J

Use this bit for intricate dovetail joints, jewelry boxes, glue joints for drawers, shadow boxes and shaker furniture.

Model	Cutting Dia. (D)	Cutting Length (H)	Angle (A)	Overall Length (L)	Shank	PRICE
105063	1/4"	3/8"	7.5°	2"	1/4"	\$6.99
107127	1/2"	1/2"	14°	2 1/4"	1/2"	\$7.49
1071901	3/4"	3/4"	14°	2 5/8"	1/2"	\$9.29





INDUSTRIAL STRENGTH ROUTER BITS

▶ **C3 INDUSTRIAL MICROGRAIN CARBIDE**
▶ **LIMITED LIFETIME WARRANTY**

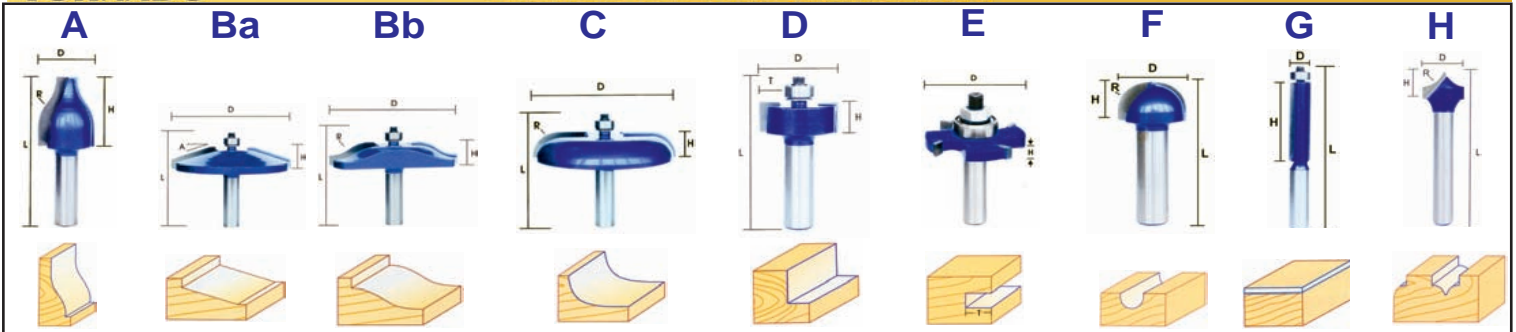

Vertical Raised Panel Bit

Image A

Make a full size raised panel using 3/4" stock vertically. The smaller diameter is great for use with single speed routers and lower horsepower routers. For use on Router Table.

Model	Cutting Dia. (D)	Cutting Length (H)	Radius	Overall Length (L)	Shank	PRICE
827286	1 1/8"	1 1/2"	7/8"	3 1/4"	1/2"	\$27.99

Slot Cutter

Image E

Fast cutting and strong this slot cutter is ideal for splines and T-moldings. This bit can also be used for rabbeting.

Model	Cutting Dia. (D)	Cutting Length (H)	Overall Depth (T)	Shank	PRICE
0955084	2"	1/8"	3/4"	1/4"	\$17.29
0955087	2"	3/16"	3/4"	1/4"	\$17.29
0955089	2"	1/4"	3/4"	1/4"	\$18.99

Raised Panel Bit – Chamfer Bits - (Ba)

Image Ba Bb

In combination with Rail and Stile cutter, you can use the raised panel cutters to produce the door of your choice. Designed for use with 3/4" stock. For use with router table.

Raised Panel Bit (Ogee Style) - (Bb)

Produce beautiful raised panel doors from 3/4" stock. Create decorative tops, plaques, moldings and much more. For use with router table.

Model	Cutting Dia. (D)	Cutting Length (H)	Radius	Overall Length (L)	Shank	PRICE
Raised Panel Bit – Chamfer Bit - (Ba)						
837889B	3 1/2"	5/8"	----	2 13/16"	1/2"	\$45.99
Raised Panel Bit (Ogee Style) - (Bb)						
827698B	2 3/4"	5/8"	5/8"	2 7/8"	1/2"	\$32.99
827889B	3 1/2"	5/8"	7/8"	2 13/16"	1/2"	\$45.99

Core Box Bits

Image F

Cuts decorative designs in cabinet doors or signs.

Model	Cutting Dia. (D)	Cutting Length (H)	Radius	Overall Length (L)	Shank	PRICE
405095	3/8"	3/8"	3/16"	1 3/4"	1/4"	\$6.99
405127	1/2"	3/8"	1/4"	1 3/4"	1/4"	\$7.99
405159	5/8"	1/2"	5/16"	1 7/8"	1/4"	\$8.99

Raised Panel Bit, Convex Type

Image C

In combination with stile and rail cutter, you can use the raised panel cutter to produce the door of your choice. Designed for use with 3/4" stock. Used for making plaques, moldings, or even decorative tops. For use on Router Table.

Model	Cutting Dia. (D)	Cutting Length (H)	Radius	Overall Length (L)	Shank	PRICE
817889B	3 1/2"	19/32"	3/4"	3 1/2"	1/2"	\$48.99

Flush Trim Bits

Image G

Great for cutting fast smooth and accurate trimming of template work or laminates. The use of two flutes makes for fast cutting.

Model	Cutting Dia. (D)	Cutting Length (H)	Overall Length (L)	Shank	PRICE
305095	3/8"	1/2"	2 3/4"	1/4"	\$ 7.99
3051271	1/2"	1"	2 3/4"	1/4"	\$ 9.49
305160	5/8"	1"	2 3/4"	1/4"	\$10.29
3071271	1/2"	1"	3 1/8"	1/2"	\$ 9.99

Rabbeting Bits

Image D

Used to inset panels in wood frames, picture frames and cabinets.

Model	Cutting Dia. (D)	Cutting Length (H)	Cutting Depth (T)	Overall Length (L)	Shank	PRICE
155254	1"	1/2"	1/4"	2 1/4"	1/4"	\$11.49
155318	1 1/4"	1/2"	3/8"	2 5/8"	1/2"	\$13.49
155381	1 1/2"	1/2"	1/2"	2 1/4"	1/4"	\$16.29

Beading Bits with Fine Point

Image H

For grooves & edge forming. Will plunge cut. Produce attractive bead profiles on furniture. Gives chatter free an extra smooth cuts.

Model	Cutting Dia. (D)	Cutting Length (H)	Radius	Overall Length (L)	Shank	PRICE
635075	19/64"	3/8"	1/8"	1 3/4"	1/4"	\$8.49
635095	3/16"	15/32"	3/16"	1 9/16"	1/4"	\$8.49





INDUSTRIAL STRENGTH ROUTER BITS

► C3 INDUSTRIAL MICROGRAIN CARBIDE
► LIMITED LIFETIME WARRANTY

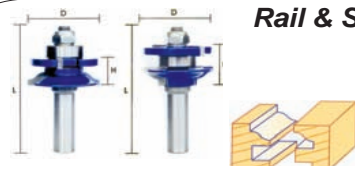

Rail & Stile Set - Ogee

Produce professional looking Rail & Stile doors. Combine this with one of the raised panel bits to create elegant crafted raised panel doors. For use with router table.

Model	Cutting Dia. (D)	Cutting Length (H)	Radius	Overall Length (L)	Shank	PRICE
857413A1	1 5/8"	11/16"	1/4"	3"	1/2"	\$68.99

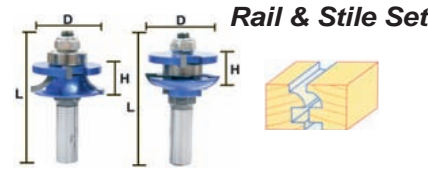

Rail & Stile Set

Produce professional looking Rail & Stile doors. Combine this with one of the raised panel bits to create elegant crafted raised panel doors. For use with router table.

Model	Cutting Dia. (D)	Cutting Length (H)	Radius	Overall Length (L)	Shank	PRICE
857413B1	1 5/8"	11/16"	1/4"	3"	1/2"	\$68.99

4pc Round Over Set



\$38.50

Model R902
Reg. \$45.00
Shank: 1/2"

- Radius: 1/8", 1/4", 3/8" & 1/2"

Raised Panel 3pc Set



\$95

Model R907
Reg. \$115.00

Shank: 1/2"

Set includes: 2 5/8" Raised Panel (Ogee) & 2pc Stile & Rail (Roman Ogee)

4pc Roundover Bit Set



\$38.50

Model R920
Reg. \$45.00

Shank: 1/4"

Set Includes: 1/8"R, 1/4"R, 3/8"R and 1/2"R Round Over bits.

6pc Straight Bit Set



\$26.99

Model R922
Reg. \$32.99

Shank: 1/4"

Set includes: The following 6 sizes: 1/4", 5/16", 3/8", 1/2", 5/8", 3/4".



Assorted 12pc Set

\$69.99

Model R926
Reg. \$79.99

Shank: 1/2"

Set Includes: 1/4", 1/2" & 5/8" Straight Bits, 1/2" Core Box, 1/2" Dovetail, 1/2" 90° V-Groove, 1/2" Trimming w/bearing, 1/4" Round Over w/bearing, 3/8" Round Over w/bearing, 1/4" Cove w/bearing, 45° Chamfer Bit w/bearing 1 1/4" & 5/32" Roman Ogee w/bearing.

Face Molding 9pc Set



\$159

Shank: 1/2"
Model R928
Reg. \$169.00

Set Includes: 4 - 2 1/4" Face Molds; 3/8"D and 1/2"D Round Over; Classical, Roman Ogee and 1/2" Round.

7pc Slot Cutter Set



\$62.50

Model R932
Reg. \$69.00

Shank: 1/2"

Set Includes: 6 different slot cutters sized: 1/16", 3/32", 1/8", 5/32", 3/16" & 1/4".



Window Sash Set 2pc

\$56.99

Model R933
Reg. \$65.00
Shank: 1/2"

Set includes: Two pieces at the following sizes:

- Cutting dia: 1 3/8"
- Cutting length: 1 3/8"
- Large radius: 1/4"
- Overall Length: 3 9/16"
- Cutting dia: 1 1/2"
- Cutting length: 5/8"
- Large radius: 1/4"
- Overall length: 2 3/8"

Shaper Cutters

3pc Raised Panel Door Set



\$225

Model S290
Reg. \$265.00
Bore: 3/4"

This large set features a 2 5/8" Stile, 2 5/8" Rail and a 4 -5/8" Raised Panel Bit Cutter.

5pc Kitchen Door & Drawer Set



\$325

Model S295
Reg. \$375.00
Bore: 3/4"

Features a 3" Drawer Lock Cutter, 2 5/8" Glue Joint Cutter, 2 5/8" Rail, 2 5/8" Stile Cutter and a 4 5/8" Raised Panel Cutter.

3pc Birds Mouth Set



\$62.50

Shank: 1/2"
Model R937
Reg. \$69.00

Three bits with different specifications allow for 6, 8, 12 or 16 sided hollow columns.

6pc Trim Bit Set



\$64.99

Shank: 1/4"
Model R939
Reg. \$75.00

Set Includes: 1/2" Flush Trim, 3/4" Flush Trim with down shear, 1/2" Pattern bit, 1/2" Pattern bit with down shear, 3/8" Overhang Bit and a Bevel Trim Bit.

6pc Dado Set



\$35.99

Shank: 1/2"
Model R941
Reg. \$42.50

With a combination of straight and undersized straight bits. Sizes: 15/64", 1/4", 15/32", 1/2", 23/32" & 3/4".



Industrial Strength Router Bits

Metal Base Plate/Bushing Set



\$22.99
Model 1201
Reg. \$26.99

- The Bushing set contains eight popular sizes
- A screw style bushing adapter also is included

Design & Inlay Kit



\$49.99
Model 1207
Reg. \$59.99

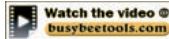

Create beautiful patterns with your router. Create myriad exciting patterns and inlay. Four easy-to-use templates included in the kit.

Sign Pro



\$69.99
Model 1212
Reg. \$79.99



- Produce a wide variety of signs of all shapes and sizes
- Includes 2 Low Profile C-Clamps

Hinge Mortise Kit



\$24.50
Model 1214
Reg. \$29.99

- Cut accurate door and jamb hinge mortises
- Comes with a tungsten carbide tipped router bit

Router Guide Kit

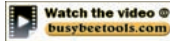

\$49.99
Model 1223
Reg. \$61.50

- 3 Tools in 1 Kit!
- Circle Compass, Edge Fence, & Offset Base.

Interior Door Kit



\$99.99
Model 1293
Reg. \$115.00

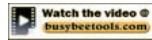

- TEMPLATES INCLUDED: Hinges: 3" and 3.5" for 1 3/8" door and jamb Strike Plate: Standard "T" and "Square" for jamb Latch Plate: 1" x 2.25" for door

3D Pantograph



\$59.99
Model 1298
Reg. \$69.99

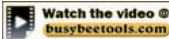

- Create carvings from 2D or 3D templates
- Constructed of high-impact styrene

Drive 90 Right Angle Driver



\$26.50
Model 1302
Reg. \$29.99

- 1/4" Hex Shaft fits ANY drill
- Bonus Bits Included! - #1 Phillips, slotted, and square drive

Joint Crafter Hand Held Doweling Jig



\$18.50
Model 1310
Reg. \$21.99

- Hand held doweling jig for precise dowel alignment yielding maximum joint strength
- Self centering design ensures holes drilled in first board are precisely on center

Joint Pro Metal Doweling Jig



\$68.50
Model 1311
Reg. \$75.00

Non slip pads included.

Quickly and accurately create strong doweled joints. Comes with Interchangeable Bushing Blocks

Drill Block™



\$9.99

Model 1312
Reg. \$12.99

- Six common drill diameters: 1/8", 3/16", 1/4", 5/16", 3/8", and 1/2"
- Centerlines ensure accurate alignment

90 Degree Angle Drive For 3/8" Drill™



\$23.99
Model 1390
Reg. \$27.99

- Drill "around corners"!
- Convert your drill into a right-angle tool!

Saw Guide



\$10.99
Model 1400
Reg. \$14.99

- With 3 separate bars and 1/16" adjustment, it fits almost all circular and jig saws. It has pivot points for circle cutting

CROWN 45 Crown Molding Jig



\$35.50
Model 1405
Reg. \$42.50

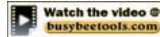

New & innovative "right side up" cutting orientation.

- Angle finders included.

Double Tandem Feather Board



\$34.99
Model 1407
Reg. \$40.99

- Can be used as 1 piece or 2
- Two feather boards 3/4" & 5/8" miter bars and T-slot bolts
- Includes spacer for tandem use and mounting hardware

4pc Tri Grips Set



\$12.99
Model 1600
Reg. \$14.99

These Non-slip friction pads hold projects in place without clamps while routing, sand, painting, etc

7pcs Twinland Drill Bit Sets



new

These radical new bits feature a patented TwinLand® 25° flute design.

Manufactured in Germany to the highest standards.

Model	Sizes	Type	Reg.	SALE
1812	1/8", 3/16", 1/4", 5/16", 3/8", 7/16", 1/2"	Imperial	\$24.99	\$21.99
1812M	4, 5, 6, 7, 8, 10 and 12	Metric	\$24.99	\$21.99

Bearing Guided Router Bit For Door Mortising



\$10.99
Model 2216
Reg. \$12.99

- 1/2" Bearing Guided Straight Router Bit
- 1/4" Shank

Laminate Trimmer
\$6.99
 Model 8403
 Reg. \$8.99



Ideal for veneer & laminate trimming.

- Design allows for close control
- Uses standard razor blade with easy blade changing

Blade Changer
\$14.99
 Model 3401
 Reg. \$17.99



A convenient way to change your table saw blade keeping the saw blade stationary while changing & keeps your fingers away from sharp teeth.

- Includes a depth gauge
- Table offsets in English or Metric
- Includes a docking station with magnetic base

Push Stick with Docking Station
\$17.50
 Model 3402
 Reg. \$20.99



8pc Dowel Tenon Center Set
\$4.29
 Model 5343
 Reg. \$6.50



- Accurately mark location of dowel holes or existing pins
- Steel centers for durable marking performance

Trim 45 Carpentry Aid
\$12.99
 Model 8401
 Reg. \$14.99



Watch the video @ busybeetools.com

- Set 1/8" to 1/2" in 1/8" increments which makes it a perfect trim tool for any project
- Use it as a built in miter gauge

Angle Finder
\$13.50
 Model 8402
 Reg. \$15.50



Find Angles Between Two Surfaces on Inside and Outside Corners with Ease.

Depth Gauge
\$6.50
 Model 8601
 Reg. \$8.50



Accurately measures, marks or locates blades, bit heights and fence offsets.

- The durable metal scale measures in inches or millimeters.

Flex Shaft XT
\$24.99
 Model 1010
 Reg. \$28.99



- Ideal for intricate work the 36" shaft provides access to spaces no rotary tool could ever go
- Accepts up to 1/8" shank accessories
- Max. load speed of 35,000 RPM

3pc Plug Cutter Set
\$15.99
 Model 5340
 Reg. \$19.99



Bits for drilling scrap project material to cover screws or hide blemishes.

Rotary Tool Stand
\$46.50
 Model 1097
 Reg. \$52.99



Elevate Your Rotary Tool's Performance. Convert Your Rotary Tool Into a Small Scale Drill Press.

Door Mortise Kit
\$36.50
 Model 1213
 Reg. \$42.99



Increase security and privacy in your home by replacing interior and exterior doors without damaging the jamb or door frame with the DoorMortiseKit

Metal Nose Turn Lock Bushing Set
\$13.99
 Model 1216
 Reg. \$16.99



Includes: 8 Popular size bushings: 5/16", 3/8", 7/16", 1/2", 5/8", 51/64", 7/16" and 5/8"

4pc Counterbit Set
\$9.99
 Model 5341
 Reg. \$12.99



TiN coated brad point pilot drill bits #6, #8, #10, and #12. (#6 bit is not brad point)

Drill Drive 90 w/Stubby Bits
\$29.99
 Model 1302KIT4
 Reg. \$39.99



- Includes: #2 Straight, #2 Phillips, #2 Square Head & Various Stubby Bits

Drill Pump 750
\$12.99
 Model 1314
 Reg. \$14.99



Designed to work with most electrical drills with a maximum speed of 2,800 RPM. 3/8" shank.

- Size: 3/4" hose

Hook Driver
\$6.50
 Model 1315
 Reg. \$8.99



Two-in-one impact ready attachment that makes driving hooks easy!

Comes with a detachable t-shaped grip handle that can be used with any 1/4" hex bit.

6pc Drill Stop Set
\$4.09
 Model 5342
 Reg. \$5.99



Includes stop collars for controlling drill bit depth to a precise setting.

Accu Drill Mate
\$36.99
 Model 1318
 Reg. \$42.00



- Adjustable from 90° to 45°
- 3/8" drill chuck with key

Long Reach Router Bits
\$20.99
 Model 2210
 Reg. \$23.99



- Size: 2 3/8" overall length
- 1/4", 3/8", and 1/2" core box bits 1/4" shank

Spring Loaded Hinge Bits
 Pre-Drill Perfectly centered holes for proper alignment. 1/4" hex shaft fits all drills.



Model	Size	No.	Reg.	SALE
2314	5/64"	4	\$7.99	\$6.59
2315	7/64"	6	\$7.99	\$6.59
2316	9/64"	8	\$7.99	\$6.59

Cabinet Mate 1/4"
\$24.99
 Model 1316
 Reg. \$27.99



Allows you to accurately drill eleven holes, evenly spaced at 32mm apart, in just one setting.

Measuring & Layout

Vernier Calipers



- Raised sliding surfaces prevent defacement and wear of graduations: clear black engravings

Model	Size	Reg.	SALE
B10556	6"	\$26.99	\$21.99
B10558	8"	\$39.99	\$34.99

GROZ 3" Steel Square



\$5.99
Model B2116
Reg. \$7.50

- Hardened & tempered tool steel ground & lapped

Outside Micrometer



\$20.99
Model B105101
Reg. \$24.99

- Outside Micrometers: 0 - 1"
- Spindle thread hardened ground and lapped
- Ratchet stop for exact readings

0" - 3" Micrometer 3pc Set



\$66.99

- Measurements in .001"
 - Positive locking clamps
 - Ratchet stop for exact reading
- Model B105203
Reg. \$79.99

6pc Telescopic Gauge Set



\$19.99
Model 220930
Reg. \$24.99

Extremely useful in measuring hollow cylinders, tubing, shafts etc...

2 in 1 Router Depth & Saw Gauge



\$5.99
Model B2386
Reg. \$7.99

- Step gauge from 1/8" to 2"
- Router depth gauge from 1/8" to 1"

GROZ Screw Cutting Gauge



\$3.99

- Thread profiles 47½° B.A., 14½° Acme, 55° and 60°
- Model B1989
Reg. \$5.99

6" Precision Level



\$99.99
Model B22926
Reg. \$115.00

For accurately checking the work of machinists and tool makers, the setting up of machinery.

300mm Stainless Steel Rule



\$2.79
Model B1813
Reg. \$3.29

- This rule is clearly graduated in 1/2mm, millimeters, 1/2cm, and centimeters
- Excellent and handy tool for precise and quick measurement!

Precision Ground 1-2-3 Blocks



\$18.99
Model B653
Reg. \$21.99

- Blocks are matched to .0001" per inch
- Measures: 1" x 2" x 3"

Angle Finder



\$2.19

- Find outward, inward and sloped angles
- Model B1729
Reg. \$3.49

"Magna Set" Magnetic Knife Setting Gauges



\$36.99
Model W1210
Reg. \$45.00
(Made in U.S.A.)

- Allows knife setting with incredible accuracy every time
- (Poly-Carbonate Body) For 4" to 8" Jointers with H.S.S. Knives

3" Desk Magnifier



\$3.69
Model B2549
Reg. \$4.50

3.5 X magnification

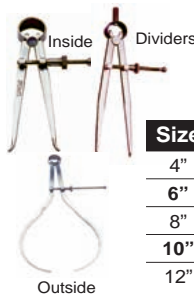

Spring Calipers And Dividers

Easy adjustment. Centrally located adjustment screw.

Spring Divider				Inside Calipers				Outside Calipers			
Size	Model	SALE		Size	Model	SALE		Size	Model	SALE	
4"	B580	\$ 4.50		4"	B581	\$ 4.50		4"	B582	\$ 4.50	
6"	B1241	\$ 5.49		6"	B1242	\$ 5.49		6"	B1243	\$ 5.49	
8"	B583	\$ 7.99		8"	B584	\$ 7.99		8"	B585	\$ 7.99	
10"	B586	\$ 9.99		10"	B587	\$ 9.99		10"	B588	\$ 9.99	
12"	B589	\$11.50		12"	B590	\$11.50		12"	B591	\$11.50	

Machinist's Protractor



\$5.99
Model B1086
Reg. \$7.99

- All brushed stainless steel
- Knurled lock knob
- 7 1/2" long
- 1/2" wide arm

Mechanics' Listening Tool



\$4.99
Model B2301
Reg. \$8.99
While Qtys. Last!

Effective wherever trouble can be traced by sound. Can easily locate and isolate trouble in engines, motors and other moving parts.

Combination Square Set



Made of high quality cast iron with 12" tempered blade in frosted chrome finish. Includes square, centre head **\$65** Model B220850 Reg. \$74.99 and protractor.

Universal Indicator Holder



- Clamping dia. 1 7/8" (Indicator not included)
 - Length to indicator 4 1/2"
 - Fits all indicators with 5/32" shank
- \$12.99**
Model B2129
Reg. \$14.99

Dial Test Indicator

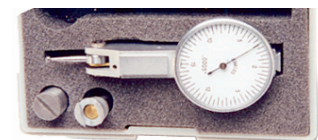

\$37.99

- Reading: 0-15-0"
 - Graduation: .0005"
 - Range: .03"
- Model B1967
Reg. \$45.00

Holding Devices

4-Way Clamp 4 Direction Pressure

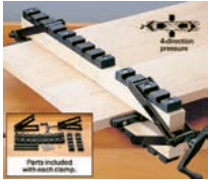

\$39.99
Model B1349
Reg. \$45.00

- For large area gluing
- All instructions included

CRAFTEX Heavy Duty 3/4" Pipe Clamp

Tens of Thousands Sold!

Weight: 1.08 kg.



\$13.99
Model B1710
Reg. \$17.99

Black pipe sold separately
Black Pipe 3/4" x 4' Threaded one end

Model B16304 Reg. \$16.99 **\$13.99**

4" Flex-Jaw Spring Clamp



\$1.29
Model B19864
Reg. \$1.69

- High strength plastic light and rust proof

Roller Stand



\$29.99
Model B025100
Reg. \$34.99

- 12 1/2" long, 1 1/4" diameter
- Fully adjustable
- 26" to 44" height
- Weight: 4 kg.

"F" Woodworking Clamps



3/4" x 3/16" serrated steel bar. Double spring lock.

Model	Size	Reg.	SALE
B214406	6"	\$ 7.99	\$ 5.99
B214408	8"	\$ 7.99	\$ 5.99
B214412	12"	\$ 8.49	\$ 6.99
B214416	16"	\$ 8.99	\$ 7.29
B214424	24"	\$10.99	\$ 8.69
B214436	36"	\$12.99	\$10.99

GROZ Table Vise Mini



\$7.99
Model B1886
Reg. \$9.99

- Made with high grade cast iron
- Handle and sliding bar are chrome plated
- Jaw width: 1 1/4"
- Weight: 1.3 kg.

GROZ 2" Clamp On Table Vise



\$10.50
Model B9862
Reg. \$12.99

Weight: 0.86 kg.

- Body made from high grade cast iron
- Clamp is provided for firm grip on table

GROZ 6" Woodworking Vise



Weight: 2.75 kg.

\$26.99
Model B2581
Reg. \$32.50

- May be clamped to any 2 1/2" bench top or attached permanently through clamping slots

7" Quick Setting Woodworker's Vise

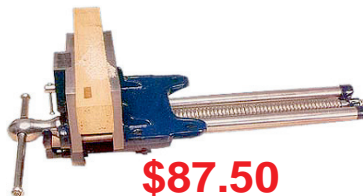

\$87.50
Model B413
Reg. \$99.99

- Jaw width: 7"
- Max. opening: 8"
- Weight: 11.2 kg.

Spring Clamps



For firmly holding together various parts of materials.

Model	Size	Reg.	SALE
B7884	4"	\$1.99	\$1.29
B7886	6"	\$3.29	\$2.49
B7888	8"	\$5.99	\$4.79

C-Clamps



- Full length screw
- Heat treated
- Cast iron

Model	Size	Reg.	SALE
B7702	2"	\$ 3.99	\$ 3.29
B7703	3"	\$ 6.99	\$ 5.29
B7704	4"	\$ 7.99	\$ 6.50
B7704	6"	\$14.99	\$11.50

6 1/2" Long Nose Pliers



\$3.19
Model B2090
Reg. \$3.99

Forged steel, polished, non-slip insulated handle coating.

9" Quick Release Woodworking Vise



\$129.99
Model B2627
Reg. \$145.00

- Adjustable front dog
- Vice jaws are equipped with a "TOE - IN" feature
- Weight: 18 kg.

GROZ 4pc Parallel Bar Clamp Set w/Four Clamp Blocks



\$169
Model B3168
Reg. \$189.99

- Includes 4 Clamps: Two 24" & two 40" parallel bar clamps & 4 clamp blocks
- 3 1/4" throat depth

Matica H. D. Ratchet Tie Down 2pc Set



- Capacity: 2,500 lbs.
 - Size: 2" x 20"
- \$15.99**
Model B2604
Reg. \$17.99

PROGRIP 96" (8 foot) Straight Edge Clamp



\$125
Model PGRIP014
Reg. \$145.00

- Width: 5"
- Includes measuring scale tape (mm)
- Cam Action locking lever for strong clamping
- Available in-store only

6" Spreader/Clamps



In a matter of seconds you can turn your clamp into an effective spreader.

Model	Size	Reg.	SALE
B240506	6"	\$12.99	\$ 9.99
B240524	24"	\$17.99	\$15.99

CRAFTEX Utility Tracks

May be mounted with screws or epoxy. Uses standard 1/4" - 20 hex bolts.

Model	Sizes	Reg.	SALE
B2527	12"	\$ 7.99	\$5.99
B2528	24"	\$ 8.99	\$6.99
B2529	36"	\$12.99	\$9.99
Hold Down For T-Track 1/4" 20 Bolt			
B2530		\$ 8.99	\$6.99

Clamp Rack for Bar Clamps



\$22.99
Model B2983
Reg. \$25.99

Clamps not included. Holds only bar clamps.

- Max recommended load is 60lbs.
- Size: 24" x 6" x 4"

Shop 24/7 @ busybeetools.com

Shop Essentials

new **Diamond Braided Poly Rope**

\$4.99
 Model B3294
 Reg. \$9.99
 (Colour may vary)
 • Size: 1/4" x 100 ft.
 • Oil, water and gasoline resistant

new **8' x 10' Tarp**

\$6.59
 Model B3297
 Reg. \$8.99
 • 4MIL thick

100pc Grommet Refill

new
\$0.99
 Model B3296
 Reg. \$2.99
 • Ergonomic design
 • To repair canvas, tarpaulins, tents, awnings, sailcloth, lawn furniture and pool covers

4pc Ratchet Set

new
\$16.59
 Model B3299
 Reg. \$24.99
 Size: 1" x 15"
 • Easily adjustable to secure loads to truck beds, roof racks, trailers
 • Vinyl covered S-hooks to prevent marring on painted surfaces

new **Steel Brush w/Long Handle**

Model B3298
 Reg. \$3.99
\$1.59
 • This brush has 4 rows of tempered steel wire
 • Ideal for a range of general applications in paint, welding and automotive trades.

Wire Brush with Handle

\$2.29
 Model B3295
 Reg. \$4.99
new
 This brush has tempered steel wire with a curved handle. Suitable for range of general applications in the paint, welding and automotive trades.

OBUSFORME Unisex Back Belt

\$29.99 each
 Reg. \$34.99
 Designed to promote proper posture for a healthy back.
B3156 - Waist: 33" - 40" Medium
B3157 - Waist: 41" - 38" Large

Clamp Rack Storage System

\$74.99
 Model D3605
 Reg. \$89.99
 Clamps not included
 • Store all of your clamps on this heavy duty system with the ability to hold over 200 clamps
 • Can support up to 500 lbs.

PORTER+CABLE 20V Max Recip. & Saw Combo

 While Qties. Last!
\$155
Special Buy Model PCCK603L2
 Reg. \$249.99

CRAFTEX Universal Mobile Bases

 • 3" Heavy Duty Wheels
 • Foot Operated Locking Cam Lift
 • Two Rubber Levelling Feet
 • Slotted Side Rails to Adjust from 12" to 52"

Model	Capacity	Reg.	SALE
CT183	450 lbs.	\$49.99	\$42.50
CT184	500 lbs.	\$59.99	\$45.99

Mobile Base

\$49.99
 Model B3086
 Reg. \$59.99
 • Simply add your own 1 1/4" square rails and this mobile base adjusts to most base sizes
 • Capacity: 300 lbs.

SHUREX Tool Table

\$62.99
 Model D2056
 Reg. \$79.99
 • Laminated M.D.F. Top measures 13" x 23"
 • Height: 30". Capacity: 700 lbs.

UHMW Slick Sheets

 This nonstick, low friction sheet gives extra smooth sliding action for jigs, fixture and fences.

Model	Size	Reg.	SALE
B237718	36" x 4" x 1/8"	\$ 7.99	\$ 5.99
B237714	36" x 4" x 1/4"	\$11.99	\$ 9.99
B237712	36" x 4" x 1/2"	\$18.99	\$16.99
B2378	36" x 7/8" x 3/8"	\$ 9.99	\$ 7.99

Steel Measuring Tape

\$3.49
 Model B2491
 Reg. \$4.49
 • Calibrated inch & metric measurements
 • Size: 3/4" x 16ft.
 • Stand out: 6.5ft.

Rocker Switches

Model	Type	Reg.	SALE
B2596	1 Pole, 2 HP, 20 Amp	\$9.99	\$6.99
B2597	2 Pole, 2 HP, 20 Amp	\$9.99	\$6.99
B2596SP	Switch Plate	Reg. \$1.29	

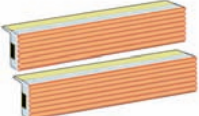
Magnetic Safe Jaws

 Soft rubber faces and magnets hold safe jaws securely in place.

Model	Jaw Width	Reg.	SALE
B16504	4"	\$7.99	\$5.99
B16505	5"	\$8.49	\$6.99

Safety Push 'V' Stick 2pc Set

 Used for table saw, jointer, shaper.
\$3.99
 Model B1843
 Reg. \$4.99

Push Pad - Extra Long

\$5.49
 Model B3104
 Reg. \$6.99
 Made of strong ABS plastic this push pad is 16" long & 2-3/4" wide. The push pad has a sticky pad for strong hold. Weight: 2 kg.

28 Flat Rate Shipping Up To 30kg. Most Orders Shipped Within 24 Hours!

Shop Essentials

"DEAD-BLOW" Shockless Hammer



With cast urethane head and tubular steel handle with nonslip rubber grip. Does not bounce.

Model	Size	Reg.	SALE
B005	1 lb.	\$11.99	\$ 9.99
B006	2 lb.	\$13.99	\$11.29

14" Utility Back Saw



\$7.99
Model B2760
Reg. \$9.99

Alloy steel blade, ground & hardened teeth, fully polished & clear lacquer coated blade.

50pc Bristle Brush Set



\$32.99
Model D2025
Reg. \$39.99

- These 100% bristle chip brushes
- Five 1/2"; Twenty 1"; Fifteen 2"; Ten 3"

5pc & 10pc Needle File Sets



5 1/2" long, various shapes easy cutting.

Model	Qty.	Reg.	SALE
B1049	5pc	\$3.99	\$2.99
B1050	10pc	\$5.99	\$4.29

Telescopic & Non-Drip Oil Can



\$3.79
Model B2857
Reg. \$4.99

- Complete with telescopic steel tube with brass nut & non drip tip
- Capacity: 200ml.

GROZ Grease Gun Push Type



\$5.99
Model B1933
Reg. \$9.99

- Standard hydraulic coupler included
- Delivery pressure: 3,000 lbs psi
- Capacity: 4oz.

Lumber Shelving Kit with Safety Pins



\$42.50
Model B2982
Reg. \$59.99

Safety pins prevent rolling.

- While Qty's. Last!
- Weight Capacity: 100 lbs. per level

2pc Set Hold Down Clamp for Workbenches



\$11.29
Model B3056
Reg. \$12.99

The set is consisting of two clamps and each clamp has a 4-1/2" hold down capacity (less workbench thickness).

5pc Spatula Set



Ideal for wood glue clean up and wood putty.

\$12.99
Model D3168
Reg. \$15.99

5pc Spatula Set



\$14.99
Model D3220
Reg. \$18.99

Just as functional as our D3168 5pc Spatula Set, but this set has different profiles for even greater versatility. 5 Different Profiles

Magnetizer/Demagnetizer



Apply or remove magnetism in seconds.

\$3.99
Model B1800
Reg. \$4.99

Full Page Magnifying Sheet



\$3.99
Model B3075
Reg. \$5.99

- Size: 7-1/2" x 11-3/4"
- 2X magnification

Anti-Fatigue Mat



- Size: 18" x 36"
- Designed to reduce fatigue

\$34.99
Model B3092
Reg. \$59.99
While Qty's. Last!

4-Sided Diamond Hone With Stand



\$34.99
Model D3657
Reg. \$45.00

Color coded honing surfaces measure 2" x 6" and include 200, 300, 400, and 600 grit. Just add water to clean and lubricate for very efficient honing. Stand features slip resistant rubber feet.

Steel Wire Brushes



Sizes:
B354: 6"
B355: 8"
Clean rust, paint and dirty surfaces

Model	Hole Dia.	Reg.	SALE
B354	1/2"	\$10.99	\$ 9.29
B355	5/8"	\$13.99	\$11.99

CRAFTEX Heavy Duty Tenon Jig



\$89.99
Model CT084
Reg. \$129.00

- Fits any 3/4" table slot with adjusters to fit
- 45° fence & micro adjustment
- Weight: 9.5 kg.

4" Rubber Tire Industrial Castors



\$5.49
Model B2420
Reg. \$7.49
FIXED
Capacity: 65 kg

\$6.99
Model B2420SW
Reg. \$8.99
SWIVEL W/BRAKE
Capacity: 65 kg.

H. D. Utility Castors Plate Style, 4pc. Set



Designed with positive -lock brake

\$6.99
Model B17862
Reg. \$9.99
2" Capacity: 220 lbs.

\$11.99
Model B17863
Reg. \$14.99
3" Capacity: 360 lbs.

5pc Ball Bearing Rollers 1" w/Flange Set



\$15.99
Model B2104
Reg. \$19.99

1" bearings allows 360° movement.

Shelf Pin Drilling Jig 18" Long



\$30.99
Model B2411
Reg. \$36.99

Bit included

- Perfectly aligned 1/4" holes 1 1/4" apart
- 37 or 64mm from edge, approx.

Drill Bit Replacements

Model B241114 - 1/4"	Reg. \$11.99	\$9.99
Model B241115MM - 5MM dia.	Reg. \$11.99	\$9.99

Band Saw Blades



LT - Precision Low Tension
(Made in Sweden)
SKT - Skip Tooth

All Blades Made To Fit CT015 & CT015N

Model	Size & TPI	Reg.	SALE
CT015018	97 1/4" x 1/8" x 0.025" 4 Raker	\$16.99	\$13.50
CT015316	97 1/4" x 3/16" 0.025" 6 Hook	\$16.99	\$13.50
CT015014	97 1/4" x 1/4" 0.025" 6 Skip	\$14.99	\$11.99
CT015038	97 1/4" x 3/8" x 0.025" 6 Hook	\$14.99	\$11.99
CT015012	97 1/4" x 1/2" x 0.025" 6 Hook	\$14.99	\$11.99
CT015034	97 1/4" x 3/4" x 0.025" 4 Hook	\$17.99	\$14.50
CT01501	97 1/4" x 1" x 0.025" 2 Hook	\$23.99	\$18.99
*CT015316LT	97 1/4" x 3/16" x .025" 10 TPI	\$29.99	\$25.99
*CT015014LT	97 1/4" x 1/4" x .025" 6 TPI	\$29.99	\$25.99
*CT015038LT	97 1/4" x 3/8" x .025" 4 TPI	\$29.99	\$25.99
*CT015012LT	97 1/4" x 1/2" x .025" 3 TPI	\$29.99	\$25.99
CT015X14	105" X 1/4" x 0.025" 4 TPI	\$16.99	\$13.50
CT015X38	105" x 3/8" x 0.032" 4 TPI	\$17.99	\$14.50
CT015X12	105" x 1/2" x 0.032" 3 TPI	\$17.99	\$14.50
CT015X34	105" x 3/4" x 0.032" 3 TPI	\$18.99	\$14.99
*CT015X316LT	105" x 3/16" x 0.025" 10 TPI	\$20.99	\$16.99
*CT015X38LT	105" x 3/8" x 0.032" 4 TPI	\$32.99	\$28.99
*CT015X12LT	105" x 1/2" x 0.032" 3 TPI	\$30.99	\$27.99
CT015038SKT	97 1/4" x 3/8" x 0.025" 4 TPI	\$14.99	\$11.99
CT015012SKT	97 1/4" x 1/2" x 0.025" 4 TPI	\$14.99	\$11.99
CT015X38SKT	105" x 3/8" x 0.032" 4 TPI	\$14.99	\$11.99
CT015X12SKT	105" x 1/2" x 0.032" 3 TPI	\$17.99	\$14.50

Model	Size & TPI	To Fit	Reg.	SALE
B227316	93 1/2" x 3/16" 6 TPI	B227N	\$14.99	\$11.99
B227018	93 1/2" x 1/8" 14 TPI	B227N	\$16.99	\$13.50
B227014	93 1/2" x 1/4" 10 TPI	B227N	\$13.99	\$10.99
B227038	93 1/2" x 3/8" 6 TPI	B227N	\$14.99	\$11.99
B227012	93 1/2" x 1/2" 6 TPI	B227N	\$14.99	\$11.99
B227034	93 1/2" x 3/4" 4 TPI	B227N	\$17.99	\$14.50
B227MB	93 1/2" Metal Cutting	B227N	\$16.99	\$13.50
*B227014LT	93 1/2" x 1/4" x 0.025" 6 TPI	B227	\$27.99	\$24.99
*B227316LT	93 1/2" x 3/16" x 0.025" 10 TPI	B227	\$27.99	\$24.99
*B227038LT	93 1/2" x 3/16" x 0.025" 4 TPI	B227	\$27.99	\$24.99
*B227012LT	93 1/2" x 1/2" x 0.025" 3 TPI	B227	\$27.99	\$24.99
B227014SKT	93 1/2" x 1/4" x 0.025" 6 TPI	B227	\$13.99	\$10.99
B227038SKT	93 1/2" x 3/8" x 0.025" 4 TPI	B227	\$14.99	\$11.99
*CX100014	114" x 1/4" x 0.025" 4 TPI	CX100	\$19.99	\$16.99
*CX100038	114" x 3/8" x 0.025" 3 TPI	CX100	\$20.99	\$17.99
*CX100012	114" x 1/2" x 0.025" 4 TPI	CX100	\$20.99	\$17.99
*CX100034	114" x 3/4" x 0.032" 3 TPI	CX100	\$27.99	\$21.99
*CX100014LT	114" x 1/4" x 0.025" 6 TPI	CX100	\$34.99	\$29.99
*CX100038LT	114" x 3/8" x 0.025" 3 TPI	CX100	\$32.99	\$27.99
*CX100012LT	114" x 1/2" x 0.025" 3 TPI	CX100	\$34.99	\$29.99
*CX100034LT	114" x 3/4" x 0.025" 3 TPI	CX100	\$44.99	\$38.99

Model	Size & TPI	To Fit	Reg.	SALE
B1209014	1/4" x 111" x 0.025" 4 Hook	B1209	\$17.99	\$14.50
B1209038	3/8" x 111" x 0.025" 4 Hook	B1209	\$17.99	\$14.50
B1209012	1/2" x 111" x 0.025" 4 Hook	B1209	\$18.99	\$14.99
B1209034	3/4" x 111" x 0.025" 4 Hook	B1209	\$17.99	\$14.50
B1209100	1" x 111" x 0.035" 2 Hook	B1209	\$26.99	\$21.50
B324018	70 1/4" x 1/8" Wood	B324	\$17.99	\$14.50
B324014	70 1/4" x 1/4" Wood	B324	\$17.99	\$14.50
B324038	70 1/4" x 3/8" Wood	B324	\$17.99	\$14.50
B324012	70 1/4" x 1/2" Wood	B324	\$20.99	\$16.99
*CT081014	94 1/2" x 1/4"	CT081	\$13.99	\$10.99
*CT081038	94 1/2" x 3/8" 6 TPI	CT081	\$14.99	\$11.99
*CT081012	94 1/2" x 1/2" 6 TPI	CT081	\$15.99	\$12.99
*CT103014	133" x 1/4" x 0.025" 6 TPI	CT103	\$17.99	\$14.50
*CT103038	133" x 3/8" x 0.025" 3 TPI	CT103	\$18.99	\$14.99
*CT103012	133" x 1/2" x 0.025" 4 TPI	CT103	\$17.99	\$14.50
*CT103034	133" x 3/4" x 0.025" 3 TPI	CT103	\$26.99	\$21.50
*CT1030342H	133" x 3/4" x 0.025" 2 TPI	CT103	\$25.99	\$20.99
*CT1030100	133" x 1" x 0.025" 3 TPI	CT103	\$29.99	\$23.99
*CT10301002H	133" x 1" x 0.025" 2 TPI	CT103	\$29.99	\$23.99
*CT103114	133" x 1 1/4" x 0.035" x 3/4" Tooth Spacing	CT103	\$58.99	\$47.99
*CT103014LT	133" x 1/4" x 6 Hook SIL	CT103	\$39.99	\$35.46
*CT103038LT	133" x 1/2" x 0.025" 4 Hook	CT103	\$39.99	\$35.49
*CT103012LT	133" x 1/2" x 3 Hook SIL	CT103	\$39.99	\$35.49
*CT103034LT	133" x 3/4" x 3 Hook SIL	CT103	\$49.99	\$43.50
*CT103100LT	133" x 1" x 0.025" 3 Hook SIL	CT103	\$49.99	\$43.50
*CX104018	101" x 1/8" x 0.025" 14 TPI	CX104	\$25.99	\$22.99
*CX10431610	101" x 3/16" x 0.025" 10 TPI Raker	CX104	\$17.99	\$14.99
*CX104014	101" x 1/4" x 0.025" 6 TPI	CX104	\$18.99	\$15.99
*CX104038	101" x 3/8" x 0.025" 4 TPI	CX104	\$18.99	\$15.99
*CX104012	101" x 1/2" x 0.025" 4 TPI	CX104	\$18.99	\$15.99
*CX104034	101" x 3/4" x 0.032" 3 TPI	CX104	\$22.99	\$19.99
*CX104316LT	101" x 3/16" x 0.025" 10 TPI	CX104	\$31.99	\$26.99
*CX104014LT	101" x 1/4" x 0.025" 6 TPI	CX104	\$31.99	\$26.99
*CX104038LT	101" x 3/8" x 0.025" 4 TPI	CX104	\$31.99	\$26.99
*CX104012LT	101" x 1/2" x 0.025" 4 TPI	CX104	\$31.99	\$26.99
*CX104316SKT	101" x 3/16" x 0.025" 4 TPI	CX104	\$17.99	\$14.99
*CX104038SKT	101" x 3/8" x 0.025" 4 TPI	CX104	\$18.99	\$15.99
*CX104012SKT	101" x 1/2" x 0.025" 4 TPI	CX104	\$18.99	\$15.99
B1108034	93" x 3/4" 14 TPI - Metal	B1108	\$18.99	\$14.99
B11080346T	93" x 3/4" 6 TPI - Metal	B1108	\$17.99	\$14.50
B110803414R	93" x 3/4" 14 TPI - Metal	B1108	\$18.99	\$14.99
B110803418R	93" x 3/4" 18 TPI - Metal	B1108	\$18.99	\$14.99
B221403410R	85 1/4" x 3/4" x 0.32" 10 TPI	B2214	\$18.99	\$14.99
B221403414R	85 1/4" x 3/4" x 0.32" 14 TPI	B2214	\$17.99	\$14.50
B221403418R	85 1/4" x 3/4" x 0.32" 18 TPI	B2214	\$18.99	\$14.99
B013012	64 1/2" x 1/2" 14 Raker	B013N	\$10.99	\$ 8.99
*B013012N	64 1/2" x 1/2" 14 TPI	B013N	\$13.49	\$11.99
B013012LT	64 1/2" x 1/2" 14 Raker	B013N	\$19.99	\$17.99
*B2393012LT	1/2" x 58" x 0.025" 14 TPI	B23930	\$19.99	\$16.99

Blades

* **new** Assorted Bi-Metal Band Saw Blades

Model	Bi-Metal, Size & TPI	To Fit	Reg.	SALE
B206001BMB	119 1/2" x 1" x 6 TPI	B2060V	\$83.99	\$67.99
*B206101BMB	130" x 1" x 0.035" 6 TPI	B2060V	\$83.99	\$67.99
*B013BMBN	64 1/2" x 0.025" 14 TPI	B013N	\$34.99	\$27.99
*B1108BMB	93" x 3/4" x 0.035" 10 TPI	B1108	\$60.99	\$48.99
*B2214BMB	85 1/4" x 3/4" x 10 TPI	B2214	\$57.99	\$46.50
*CT081012BMB	94 1/2" X 1/2" X 0.025"	CT081	\$59.99	\$47.99
CT116014BMB	97" x 1/4" 14 TPI	CT116	\$56.99	\$47.99
CT116012BMB	97" x 1/2" 14 TPI	CT116	\$56.99	\$47.99
*CX101014MB	133" x 1/4" x 0.025" 14 TPI	CX101	\$72.99	\$67.50
*CX101012MB	133" x 1/2" x 0.025" 14 TPI	CX101	\$72.99	\$67.50
*CX112BMB	56 1/2" X 1/2" 14 TPI	CX112	\$23.99	\$18.99

Carbon - Hard Edge Band Saw Blades

Model	Size & TPI	To Fit	Reg.	SALE
B132912	156" x 1/2" 3 TPI - Metal	B1329	\$19.99	\$15.99
B132934	156" x 3/4" 3 TPI - Metal	B1329	\$26.99	\$21.50
B13291	156" x 1" 2 TPI - Metal	B1329	\$31.99	\$24.99
CT11601218R	97" x 1/2" x 0.025" 18 TPI Metal	CT116	\$17.99	\$14.99
B1012058	77" x 5/8" 4 TPI - Meat Saw	B1012	\$20.99	\$16.99



Carbide Tipped Economy Saw Blades

Thin Kerf (Power Saving) **THOUSANDS OF BLADES SOLD!**
Anti-Kick Back Design.



ATB:
Alternate Top Bevel Grind
COMB:
Combination Grind
FLAT:
Flat Top Grind
TCG:
Triple Chip Grind

Model	Dia.	Teeth	Arbor	Reg.	SALE
CT060	7"	40 ATB	5/8"	\$14.99	\$11.29
CT061	8"	40 ATB	5/8"	\$15.99	\$12.99
CT062	10"	36 ATB	5/8"	\$21.99	\$18.99
CT063	10"	40 ATB	5/8"	\$22.99	\$19.49
CT064	10"	60 COMB	5/8"	\$25.99	\$22.99
CT065	10"	60 TCG	5/8"	\$25.99	\$22.99
CT066	10"	80 FLAT	5/8"	\$28.99	\$25.99
CT067	10"	80 COMB	5/8"	\$26.99	\$22.50
CT068	10"	80 ATB	5/8"	\$29.99	\$25.99
CT069	10"	100 TCG	5/8"	\$34.99	\$28.99
CT070	12"	40 ATB	1"	\$26.99	\$23.50
CT071	12"	60 COMB	1"	\$30.99	\$26.99
CT072	12"	100 ATB	1"	\$37.99	\$33.99

Thin Kerf Carbide Tipped Saw Blades

Anti-kick back design 5/8" Bore
TK307 1" Bore



TK213

Model	Size	Teeth	Reg.	SALE
TK604	8 1/2"	60	\$ 95.00	\$ 65.00
TK305	9"	40	\$ 47.99	\$ 42.99
TK206	10"	24	\$ 47.99	\$ 42.99
TK406	10"	60	\$ 89.99	\$ 62.50
TK806	10"	80	\$115.00	\$ 79.99
LU82M010	10"	60 TCG	\$ 75.00	\$ 49.99
*LU97R010	10"	80 TCG	\$185.00	\$115.00



For Information on Blades visit: www.busybeetools.com

BUY DIRECT & SAVE!



Bi-Metal Reciprocating Saw Blade Sets



- These specially designed blades include a variable tooth design for superior cuts in nail embedded wood, wood and metal
- Bi-Metal blades combined with Variable Tooth Technology gives up to two times longer life than standard blades.

Model	Quantity	Reg.	SALE
DS006SC	6pc	\$29.99	\$14.99
DS0012SC	12pc	\$39.99	\$24.99

10" Saw Blade Holder



\$2.99
Model B1842
Reg. \$4.99

Blade not included

12" Saw Blade Holder



\$4.99
Model B3037
Reg. \$5.99

Protect your valuable carbide tipped blades with this saw blade holder. Ideal for storing and for transporting your blades.

Sharpening Tools



Drill Bit Sharpening Kit



\$179
Model DD750X
Reg. \$225.00

- Designed for durability and has the flexibility to sharpen bits from 3/32" to 3/4" in any angle; 115° to 140°



Sharpening System 3000



\$225
Model WS3000
Reg. \$269.00

- This system allows you to sharpen your tools in 3 dry, easy and quick ways
- Includes an instructional DVD
- 2 Year Warranty



Knife & Tool Sharpener



\$88.99
Model WSKTSC
Reg. \$115.00

Allows you to sharpen any knife you own including serrated knives.

Replacement Belt Kits
Model WSSA0002223 Reg. \$12.99 **\$10.99**

Shop 24/7 @ busybeetools.com



Busy Bee Tools
 130 Great Gulf Drive
 Concord, Ontario
 L4K 5W1

CANADA POSTES
 POST CANADA
 Postage paid
 Addressed
 Admail
 1681621
 Post payé
 Médiaspéciale
 avec adresse

STORE LOCATIONS

- CONCORD (HEAD OFFICE)(905) 738-5115
- MISSISSAUGA, ON(905) 812-3202
- PICKERING, ON(905) 831-9582
- BARRIE, ON(705) 730-0498
- LONDON, ON(519) 659-9868
- OTTAWA, ON(613) 526-4696
- CALGARY, AB(403) 250-1986
- EDMONTON, AB(780) 487-1202
- DARTMOUTH, NS(902) 468-8088
- NEW WESTMINSTER, BC(604) 517-3922

FOR DETAILED MAPS & STORE HOURS,
 PLEASE SEE PAGE 18.

ERRORS & OMISSIONS EXCEPTED
 PRINTED IN CANADA.



Cargo and SUV Liner



- The Wahl Cargo Liner protects your vehicle's interior from pet hair, dirt, damage and moisture.
- Provides added comfort for your pet while travelling
- Fits most standard sized SUV's; easy to install and remove

\$19⁹⁹

B3215 - Reg. \$29.99

O'Keeffe's Working Hands Cream



A highly effective, non-greasy and odorless moisturizer for severely dry skin that frequently cracks and splits.

Ideal for those of us who are always using our hands for something creative.

- 3.4 oz

\$7⁹⁹

K1350013 - Reg. \$9.49



Speedmatic Fixed Base Router



- 15 Amps, 3-1/4 HP
- 5 Speeds
- Soft Start
- Auto release collet system

*While Quantities Last

\$45⁹

7518 - Reg. \$495



16pc Mini Clamp Set



- 8 - 1" Spring Clamp
- 2 - 1-1/2" Spring Clamp
- 2 - 4" Quick Release Bar Clamp
- 1 - 1-5/8" C-Clamp
- 1 - 1-1/8" C-Clamp
- 1 - 3/4" C-Clamp
- 1 - C-Clamp Magnetic Base

\$19⁹⁹

Fitted Plastic Carrying Case Included

D3628 - Reg. \$24.99

While Qtys. Last!

1, 2 & 3 Ton Arbor Presses

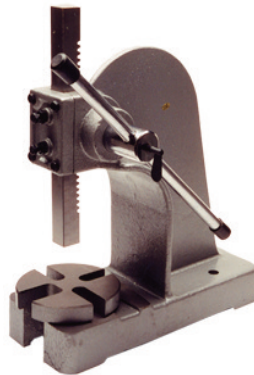

These cast arbor presses allow for near effortless seating, stamping, removal of bearings and other operations. These presses are simple to use, well made and are an ideal bench tool for your workshop.

- Heavy teeth
- 4-position anvil
- Heavy cast iron body
- Steel rams and pinions

Model	Ton	Throat	Height	Weight	Reg.	Price
B091	1	4"	5"	14 kg.	\$ 99.00	\$ 89.99
B092	2	5"	8"	35 kg.	\$245.00	\$149.00
B093	3	6"	12"	69 kg.	\$399.00	\$259.00

3 DAY FATHER'S DAY SALE



- 25% OFF Select Hand Tools
- 25% OFF Select Dust Collection
- Exclusive Deals for Dad

ALL BRANCHES & ONLINE

JUNE 18TH, 19TH & 20TH, 2015

COMING SOON!
NEW CRAFTEX CX-SERIES SHEET METAL MACHINES, LATHES & COMBINATION MACHINES



See website for details

1-800-461-BUSY (2879)

busybeetools.com

SUMMER SALE ENDS AUGUST 8TH, 2015