

STAND FOR 13" intelliCarve MACHINE

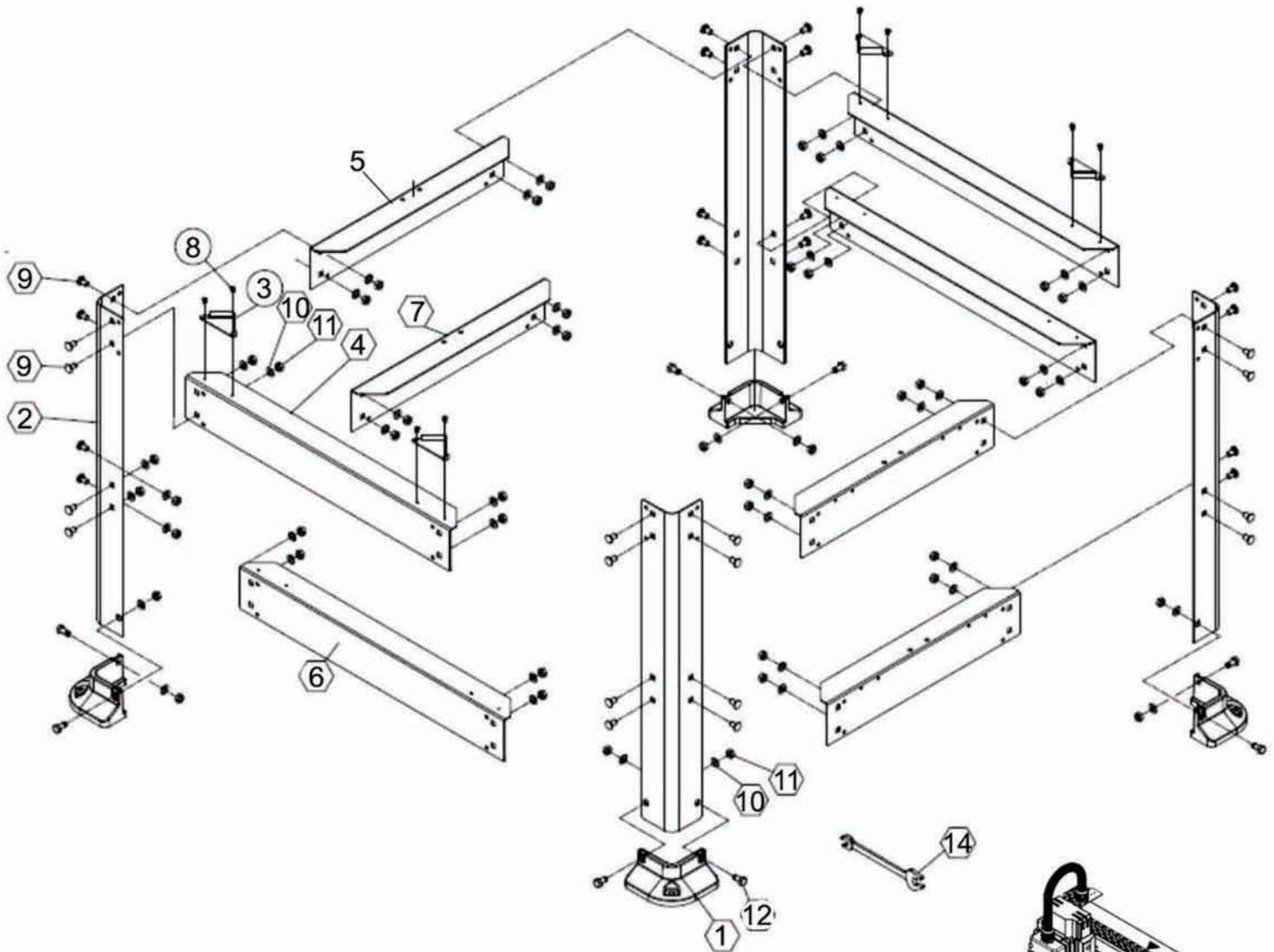

NO.	PART NO.	DESCRIPTION	QTY	
1	250900-615	FOOT PAD	4	
2	170837-008	LEG	4	
3	173350-008	BRACKET FOR MACHINE	4	
4	173346-008	UPPER LONG BRACE	2	
5	173347-008	UPPER SHORT BRACE	2	
6		LOWER LONG BRACE	2	
7		LOWER SHORT BRACE	2	
8	000302-101	PHILLIPS HEAD SCREW	M4*0.7P*6	8
*9	001001-101	CARRIAGE BOLT	M8*1.25P*16	32
*10	006001-054	FLAT WASHER	8.5*20*2.0t	40
*11	008006-100	HEX. NUT	M8*1.25P	40
*12	000003-102	HEX. SCREW	M8*1.25P*16	8
*14	040203-000	OPEN WRENCH	11*13mm	1

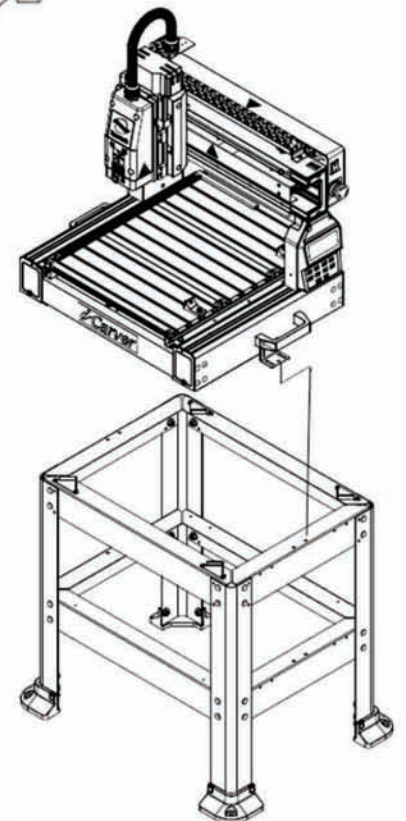

" * " Hardware Bag