

## 14" Deluxe Bandsaw

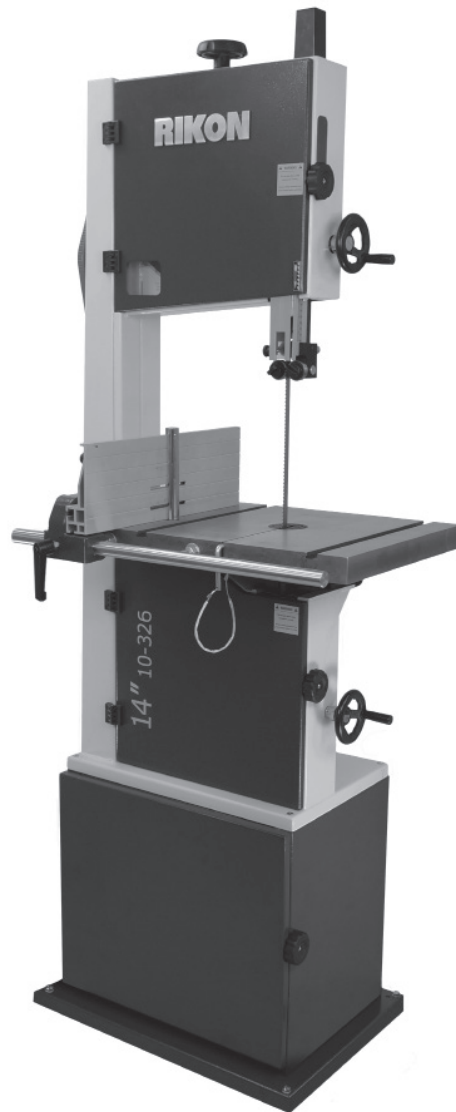

# Operator's Manual

Record the serial number and date of purchase in your manual for future reference.

Serial Number: \_\_\_\_\_ Date of purchase: \_\_\_\_\_

For technical support or parts questions, email [techsupport@rikontools.com](mailto:techsupport@rikontools.com) or call toll free at (877)884-5167

## TABLE OF CONTENTS

Specifications.....	2
Safety Instructions .....	3 - 6
Getting To Know Your Machine .....	7
Contents of Package .....	8 - 9
Installation .....	8
Assembly .....	10 - 13
Adjustments.....	13 - 22
Operation .....	22
Maintenance .....	23
Electricals & Wiring Diagram .....	5 & 23
Troubleshooting .....	24 - 27
Parts Diagrams & Parts Lists .....	28 - 39
How To Guide for all Band Saw Blades .....	40
Warranty .....	41
Accessories .....	42
Notes .....	43

## SPECIFICATIONS

Motor .....	1.75 HP, TEFC
Motor Speed (no load).....	1,720 RPM
Volts .....	115 / 230 V
Amps, Hertz, Phase .....	14 / 7 A, 60 Hz, 1Ph
Blade Length .....	111" (2,819 mm)
Blade Width .....	3/16" - 3/4" (4.78 - 19 mm)
Blade Speed .....	1,445 / 2,950 ft/min (440.5 / 899.2 m/min)
Table Size (W x D) .....	21-1/2" x 15-3/4" (546 x 400 mm)
Table Tilt .....	Left -7°, Right 45°
Miter Gauge T-Slots (2) .....	3/4" x 3/8"
Maximum Cutting Width (throat) .....	13-5/8" (346 mm)
Maximum Cutting Depth (height) .....	13" (330 mm)
Table Height .....	40-3/8" (1,026 mm)
Fence Height .....	6" (152 mm)
Fence Length .....	18-3/4" (476 mm)
Dust Ports (1) .....	4" Diameter (100 mm)
Base Size (LxWxH) .....	24" x 17-5/16" x 1-3/16" (610 x 440 x 30 mm)
Overall Height .....	74-1/2" (1,892 mm)
Overall Width x Depth.....	34-1/4" x 25-13/16" (870 x 656mm)
Net Weight .....	285 lbs (129 kg)

**NOTE:** The specifications, photographs, drawings and information in this manual represent the current model when the manual was prepared. Changes and improvements may be made at any time, with no obligation on the part of Rikon Power Tools, Inc. to modify previously delivered units. Reasonable care has been taken to ensure that the information in this manual is correct, to provide you with the guidelines for the proper safety, assembly and operation of this machine.

# SAFETY INSTRUCTIONS

**IMPORTANT!** Safety is the single most important consideration in the operation of this equipment. **The following instructions must be followed at all times.** Failure to follow all instructions listed below may result in electric shock, fire, and/or serious personal injury.

There are certain applications for which this tool was designed. We strongly recommend that this tool not be modified and/or used for any other application other than that for which it was designed. If you have any questions about its application, do not use the tool until you have contacted us and we have advised you.

## SAFETY SYMBOLS



**SAFETY ALERT SYMBOL:** Indicates DANGER, WARNING, or CAUTION. This symbol may be used in conjunction with other symbols or pictographs.



Indicates an imminently hazardous situation, which, if not avoided, could result in death or serious injury.



Indicates a potentially hazardous situation, which, if not avoided, could result in death or serious injury.



Indicates a potentially hazardous situation, which, if not avoided, could result in minor or moderate injury.

**NOTICE:** Shown without Safety Alert Symbol indicates a situation that may result in property damage.

## GENERAL SAFETY

**KNOW YOUR POWER TOOL.** Read the owner's manual carefully. Learn the tool's applications, work capabilities, and its specific potential hazards.

### BEFORE USING YOUR MACHINE

To avoid serious injury and damage to the tool, read and follow all of the Safety and Operating Instructions before operating the machine.

1. Some dust created by using power tools contains chemicals known to the State of California to cause cancer, birth defects, or other reproductive harm.

Some examples of these chemicals are:

- Lead from lead-based paints.
- Crystalline silica from bricks, cement, and other masonry products.
- Arsenic and chromium from chemically treated lumber.

Your risk from these exposures varies, depending on how often you do this type of work. To reduce your exposure to these chemicals: work in a well ventilated area and work with approved safety equipment, such as those dust masks that are specially designed to filter out microscopic particles.

2. **READ** the entire Owner's Manual. **LEARN** how to use the tool for its intended applications.

3. **GROUND ALL TOOLS.** If the tool is supplied with a 3 prong plug, it must be plugged into a 3-contact electrical receptacle. The 3rd prong is used to ground the tool and provide protection against accidental electric shock. **DO NOT** remove the 3rd prong. See Grounding Instructions on the following pages.

4. **AVOID A DANGEROUS WORKING ENVIRONMENT.** **DO NOT** use electrical tools in a damp environment or expose them to rain.

5. **DO NOT** use electrical tools in the presence of flammable liquids or gasses.

6. **ALWAYS** keep the work area clean, well lit, and organized. **DO NOT** work in an environment with floor surfaces that are slippery from debris, grease, and wax.

7. **KEEP VISITORS AND CHILDREN AWAY. DO NOT** permit people to be in the immediate work area, especially when the electrical tool is operating.

8. **DO NOT FORCE THE TOOL** to perform an operation for which it was not designed. It will do a safer and higher quality job by only performing operations for which the tool was intended.

9. **WEAR PROPER CLOTHING. DO NOT** wear loose clothing, gloves, neckties, or jewelry. These items can get caught in the machine during operations and pull the operator into the moving parts. The user must wear a protective cover on their hair, if the hair is long, to prevent it from contacting any moving parts.

10. **CHILDPROOF THE WORKSHOP AREA** by removing switch keys, unplugging tools from the electrical receptacles, and using padlocks.

11. **ALWAYS UNPLUG THE TOOL FROM THE ELECTRICAL RECEPTACLE** when making adjustments, changing parts or performing any maintenance.

# SAFETY INSTRUCTIONS

**12. KEEP PROTECTIVE GUARDS IN PLACE AND IN WORKING ORDER.**

**13. AVOID ACCIDENTAL STARTING.** Make sure that the power switch is in the “OFF” position before plugging in the power cord to the electrical receptacle.

**14. REMOVE ALL MAINTENANCE TOOLS** from the immediate area prior to turning “ON” the machine.

**15. USE ONLY RECOMMENDED ACCESSORIES.** Use of incorrect or improper accessories could cause serious injury to the operator and cause damage to the tool. If in doubt, check the instruction manual that comes with that particular accessory.

**16. NEVER LEAVE A RUNNING TOOL UNATTENDED.** Turn the power switch to the “OFF” position. **DO NOT** leave the tool until it has come to a complete stop.

**17. DO NOT STAND ON A TOOL.** Serious injury could result if the tool tips over, or you accidentally contact the tool.

**18. DO NOT** store anything above or near the tool where anyone might try to stand on the tool to reach it.

**19. MAINTAIN YOUR BALANCE. DO NOT** extend yourself over the tool. Wear oil resistant rubber soled shoes. Keep floor clear of debris, grease, and wax.

**20. MAINTAIN TOOLS WITH CARE.** Always keep tools clean and in good working order. Keep all blades and tool bits sharp, dress grinding wheels and change other abrasive accessories when worn.

**21. EACH AND EVERY TIME, CHECK FOR DAMAGED PARTS PRIOR TO USING THE TOOL.** Carefully check all guards to see that they operate properly, are not damaged, and perform their intended functions. Check for alignment, binding or breaking of moving parts. A guard or other part that is damaged should be immediately repaired or replaced.

**22. DO NOT OPERATE TOOL WHILE TIRED, OR UNDER THE INFLUENCE OF DRUGS, MEDICATION OR ALCOHOL.**

**23. SECURE ALL WORK.** Use clamps or jigs to secure the work piece. This is safer than attempting to hold the work piece with your hands.

**24. STAY ALERT, WATCH WHAT YOU ARE DOING, AND USE COMMON SENSE WHEN OPERATING A POWER TOOL.**  
A moment of inattention while operating power tools may result in serious personal injury.

**25. ALWAYS WEAR A DUST MASK TO PREVENT INHALING DANGEROUS DUST OR AIRBORNE PARTICLES,** including wood dust, crystalline silica dust and asbestos dust. Direct particles away from face and body. Always operate tool in well ventilated area and provide for proper dust removal. Use dust collection system wherever possible. Exposure to the dust may cause serious and permanent respiratory or other injury, including silicosis (a serious lung disease), cancer, and death. Avoid breathing the dust, and avoid prolonged contact with dust. Allowing dust to get into your mouth or eyes, or lay on your skin may promote absorption of harmful material. Always use properly fitting NIOSH/OSHA approved respiratory protection appropriate for the dust exposure, and wash exposed areas with soap and water.

**26. USE A PROPER EXTENSION CORD IN GOOD CONDITION.** When using an extension cord, be sure to use one heavy enough to carry the current your product will draw. The table on the following page shows the correct size to use depending on cord length and nameplate amperage rating. If in doubt, use the next heavier gauge. The smaller the gauge number, the larger diameter of the extension cord. If in doubt of the proper size of an extension cord, use a shorter and thicker cord. An undersized cord will cause a drop in line voltage resulting in a loss of power and overheating.  
**USE ONLY A 3-WIRE EXTENSION CORD THAT HAS A 3-PRONG GROUNDING PLUG AND A 3-POLE RECEPTACLE THAT ACCEPTS THE TOOL’S PLUG.**

**27. ADDITIONAL INFORMATION** regarding the safe and proper operation of this product is available from:

- Power Tool Institute  
1300 Summer Avenue  
Cleveland, OH 44115-2851  
[www.powertoolinstitute.org](http://www.powertoolinstitute.org)
- National Safety Council  
1121 Spring Lake Drive  
Itasca, IL 60143-3201  
[www.nsc.org](http://www.nsc.org)
- American National Standards Institute  
25 West 43rd Street, 4th Floor  
New York, NY 10036  
[www.ansi.org](http://www.ansi.org)
- ANSI 01.1 Safety Requirements for Woodworking Machines and the U.S. Department of Labor regulations  
[www.osha.gov](http://www.osha.gov)

**28. SAVE THESE INSTRUCTIONS.** Refer to them frequently and use them to instruct others.

# SAFETY INSTRUCTIONS

## ELECTRICAL SAFETY

**⚠ WARNING:** THIS TOOL IS PRE-WIRED FOR 115V CIRCUITS, AND MUST BE GROUNDED WHILE IN USE TO PROTECT THE OPERATOR FROM ELECTRIC SHOCK.

**IN THE EVENT OF A MALFUNCTION OR BREAKDOWN,** grounding provides the path of least resistance for electric current and reduces the risk of electric shock. This tool is equipped with an electric cord that has an equipment grounding conductor and requires a grounding plug (not included). The plug **MUST** be plugged into a matching electrical receptacle that is properly installed and grounded in accordance with **ALL** local codes and ordinances.

**DO NOT MODIFY ANY PLUG.** If it will not fit the electrical receptacle, have the proper electrical receptacle installed by a qualified electrician.

**IMPROPER ELECTRICAL CONNECTION** of the equipment grounding conductor can result in risk of electric shock. The conductor with the green insulation (with or without yellow stripes) is the equipment grounding conductor. **DO NOT** connect the equipment grounding conductor to a live terminal if repair or replacement of the electric cord or plug is necessary.

**CHECK** with a qualified electrician or service personnel if you do not completely understand the grounding instructions, or if you are not sure the tool is properly grounded when installing or replacing a plug.

**USE ONLY A 3-WIRE EXTENSION CORD THAT HAS THE PROPER TYPE OF A 3-PRONG GROUNDING PLUG THAT MATCHES THE MACHINE'S 3-PRONG PLUG AND ALSO THE 3-POLE RECEPTACLE THAT ACCEPTS THE TOOL'S PLUG.** \* See Figures A and B.

**REPLACE A DAMAGED OR WORN CORD IMMEDIATELY.**

This tool is intended for use on a circuit that has a 120 volt electrical receptacle. **FIGURE C** shows the type of the 220V, 3-wire electrical plug and electrical receptacle that has a grounding conductor that is required if the motor wiring is changed. See page 23.

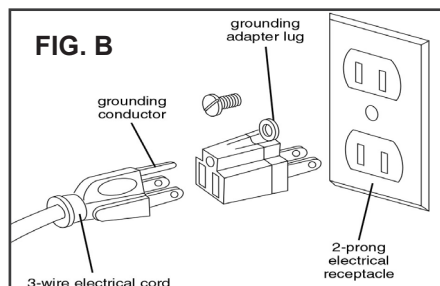
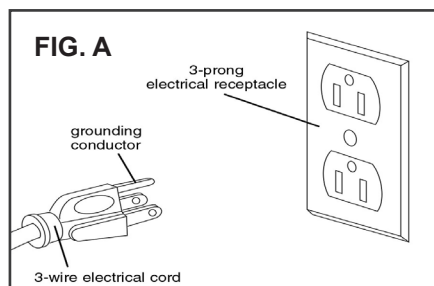

## EXTENSION CORDS

**⚠ WARNING:** THE USE OF AN EXTENSION CORD WITH THIS MACHINE IS NOT RECOMMENDED. For best power and safety, plug the machine directly into a dedicated, grounded electrical outlet that is within the supplied cord length of the machine.

If an extension cord needs to be used, it should only be for a limited operation of the machine. The extension cord should be as short as possible in length, and have a minimum gauge size of 14AWG.

**⚠ WARNING:** Check extension cords before each use. If damaged replace immediately. Never use a tool with a damaged cord, since touching the damaged area could cause electrical shock, and serious injury.

Use a proper extension cord. Only use cords listed by Underwriters Laboratories (UL). Other extension cords can cause a drop in line voltage, resulting in a loss of power and overheating of tool. When operating a power tool outdoors, use an outdoor extension cord marked "W-A" or "W". These cords are rated for outdoor use and reduce the risk of electric shock.

### MINIMUM RECOMMENDED GAUGE FOR EXTENSION CORDS (AWG)

120 VOLT OPERATION ONLY				
	25' LONG	50' LONG	100' LONG	150' LONG
0 to 6 Amps	18 AWG	16 AWG	16 AWG	14 AWG
6 to 10 Amps	18 AWG	16 AWG	14 AWG	12 AWG
10 to 12 Amps	16 AWG	16 AWG	14 AWG	12 AWG

**⚠ WARNING:** Keep the extension cord clear of the working area. Position the cord so that it will not get caught on lumber, tools or other obstructions while you are working with your power tool.

\* Canadian electrical codes require extension cords to be certified SJT type or better.

\*\* The use of an adapter in Canada is not acceptable.

**FIG. C** Sample of 220 volt plug if motor wiring is changed.



NEMA 6-15P

Consult a qualified electrician if the distance of the machine from the electrical panel is greater than 30 feet.



# SAFETY INSTRUCTIONS

## SPECIFIC SAFETY INSTRUCTIONS FOR BAND SAWS

This machine is intended for the cutting of natural, solid woods, composite materials, plastics and non-ferrus metals. The permissible workpiece dimensions must be observed (see Technical Specification). Any other use not as specified, including modification of the machine or use of parts not tested and approved by the equipment manufacturer, can cause unforeseen damage and invalidate the warranty.

**ATTENTION:** Use of this band saw still presents risks that cannot be eliminated by the manufacturer. Therefore, the user must be aware that wood working machines are dangerous if not used with care and all safety precautions are adhered to.

1. Do not operate this machine until you have read all of the following instructions.
2. If you are not familiar with the operation of the machine, obtain assistance from a qualified person.
3. Always wear approved, safety protective eye wear and hearing protection when operating this machine.
4. Always wear a dust mask and use adequate dust collection and proper ventilation.
5. Adjust the upper guides about 1/8" to 1/4" above the material being cut.
6. Check for proper blade size and type for the thickness and type of material being cut.
7. Make sure that the blade tension and blade tracking are properly adjusted.
8. Always keep hands and fingers away from the blade.
9. Make "relief" cuts before cutting curves to eliminate blade binding.
10. Always hold material firmly, resting flat on the table and feed it into the blade at a moderate speed.
11. Never attempt to saw stock that does not have a flat surface, unless a suitable support is used.
12. When cutting small work pieces, always use a push stick, holding jig or other device to keep your hands safely away from the blade. Use 'Zero Clearance Inserts' to prevent small pieces from becoming jammed in the table insert or lower blade guides.
13. Always allow the bandsaw blade to stop before removing scrap pieces from the table.
14. Do not remove jammed pieces from the saw until the machine and blade has stopped. Unplug the bandsaw from the power source, and then remove the jammed work piece.
15. Always turn off the machine if the material is to be backed out of an uncompleted cut.
16. Use extra supports (roller stands, saw horses, tables etc.) for any work pieces large enough to tip when not held down to the table top surface.
17. Always turn off and unplug the machine when changing blades or servicing the machine.
18. Release blade tension when the saw will not be used for a long period of time.
19. Remove material or debris from the work area. Keep work area neat and clean.

## SAVE THESE INSTRUCTIONS.

Refer to them often.

### California Proposition 65 Warning

**WARNING:** Some dust created by power sanding, sawing, grinding, drilling, and other construction activities contains chemicals known to the State of California to cause cancer and birth defects or other reproductive harm. Your risk from exposure to these chemicals varies, depending on how often you do this type of work. To reduce your exposure, work in a well-ventilated area and with approved safety equipment, such as dust masks that are specially designed to filter out microscopic particles.

For more detailed information about California Proposition 65 log onto [rikontools.com](http://rikontools.com).

**This owner's manual is not a teaching aid. Use of this owner's manual is intended to show assembly, adjustments, and general use.**

## GETTING TO KNOW YOUR MACHINE

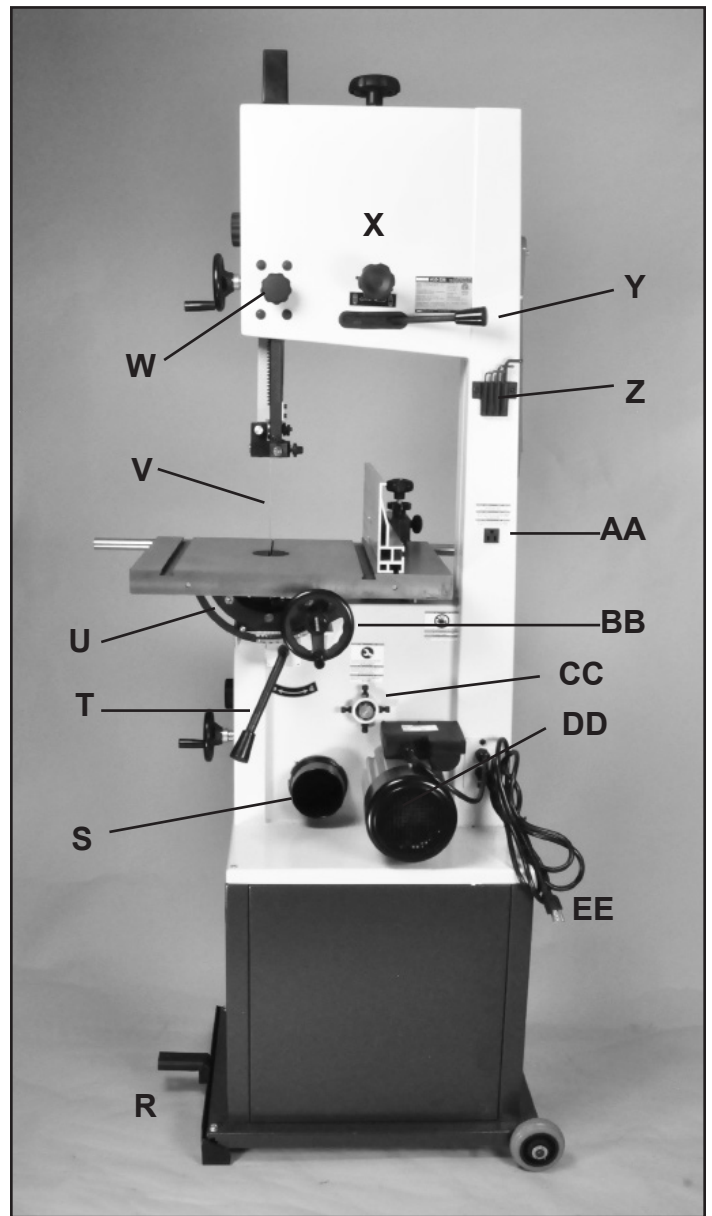
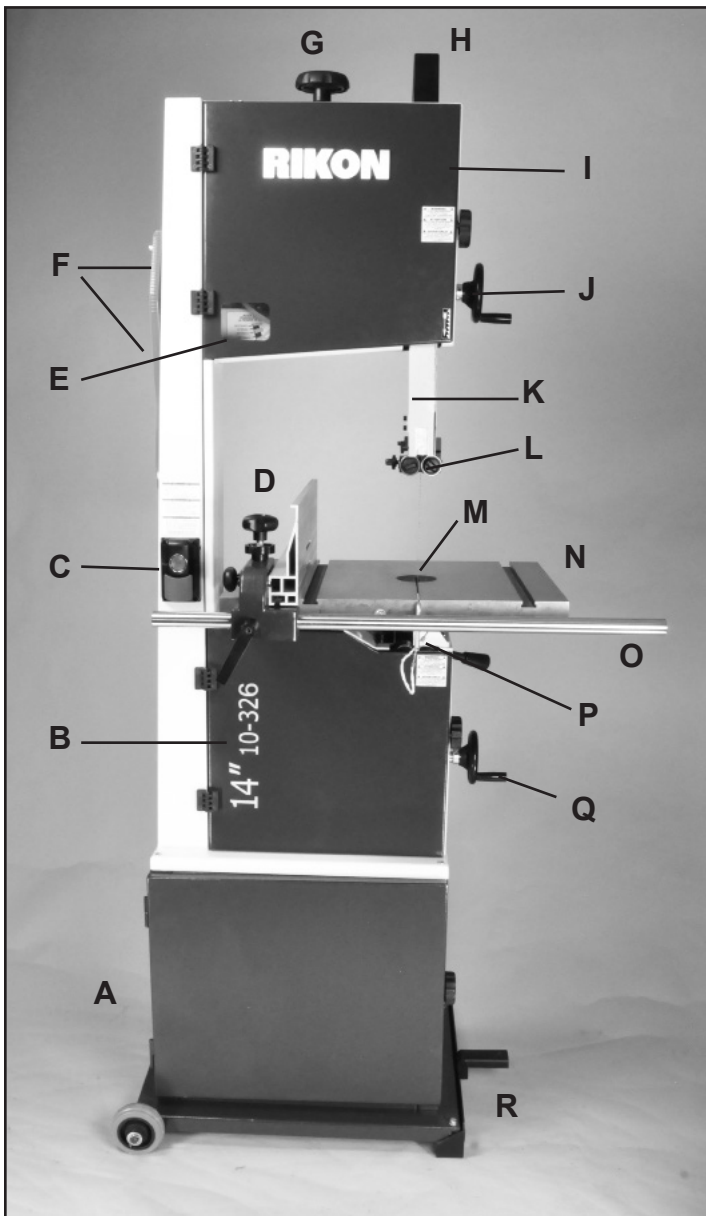

10-326 BANDSAW SHOWN WITH OPTIONAL MOBILITY KIT BASE ATTACHED (13-325). OPTIONAL TOW BAR NOT SHOWN.

- A. Base Cabinet
- B. Lower Door
- C. ON / OFF Switch
- D. Rip Fence Assembly
- E. Blade Tension Window
- F. Push Stick & Tow Bar Hanger Bolts
- G. Blade Tension Handle
- H. Guide Post Cap
- I. Upper Door & Blade Tracking Window
- J. Blade Guard Adjustment Hand Wheel
- K. Blade Guard with Scale
- L. Upper Blade Guides
- M. Table Insert
- N. Table with Miter Gauge T-Slots
- O. Front Rail for Rip Fence
- P. Lower Blade Guides and Guard

- Q. Drive Belt Tension Hand Wheel
- R. Mobility Kit (Optional Accessory)
- S. 4" Dust Port
- T. Quick Release Table Locking Handle
- U. Trunnion with Angle Scale
- V. Bandsaw Blade
- W. Guide Post Lock Knob
- X. Blade Tracking Handle & Lock Lever
- Y. Quick Release Blade Tension Lever
- Z. Tool Holder
- AA. Electrical Outlet
- BB. Table Tilt Hand Wheel
- CC. Lower Wheel Shaft Fasteners
- DD. Motor
- EE. Power Cord

# CONTENTS OF PACKAGE

Model 10-326 14" Deluxe Bandsaw is shipped complete in one box.

## Unpacking, Checking Contents & Clean-up

1. Carefully remove all contents from the shipping carton. Compare the contents with the list of contents to make sure that all of the items are accounted for, before discarding any packing material. Place parts on a protected surface for easy identification and assembly. If any parts are missing or broken, please call RIKON Customer Service (877- 884-5167) as soon as possible for replacements. **DO NOT** turn your machine **ON** if any of these items are missing. You may cause injury to yourself or damage to the machine.
2. Report any shipping damage to your local distributor. Take photographs for any possible insurance claims.
3. With the help of another person, carefully lift the Bandsaw from the packaging and place it on a level floor.
4. Clean all rust protected surfaces with ordinary house hold type grease or spot remover. Do not use; gasoline, paint thinner, mineral spirits, etc. These may damage painted surfaces.
5. Apply a coat of paste wax to the table to prevent rust. Wipe all parts thoroughly with a clean dry cloth. Be careful, as the pre-installed bandsaw blade has sharp teeth and may cause injury if touched.
6. Set packing material and shipping carton aside. Do not discard until the machine has been set up and is running properly.

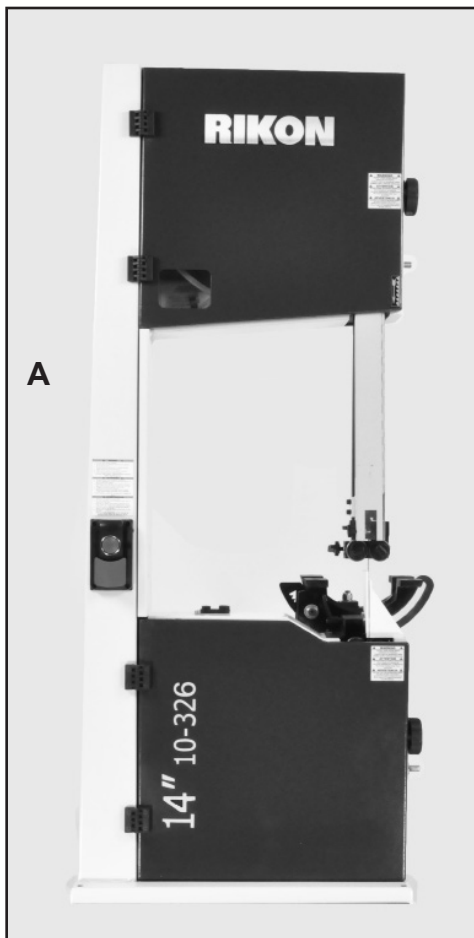

## TABLE OF LOOSE PARTS

- A. Bandsaw Frame Assembly
- B. Base Cabinet Assembly - see page 10 for Parts List
- C. Trunion Hand Wheel and Handle
- D. Hand Wheel for Raising Blade Guard
- E. Hand Wheel for Tensioning the Drive Belt
- F. Manual and Warranty Card - not shown

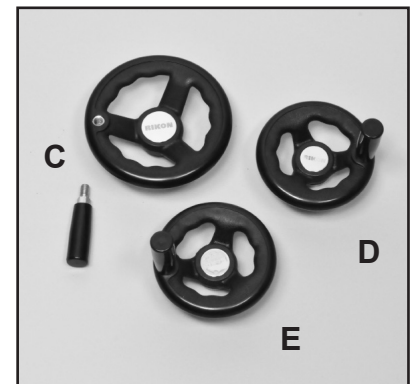
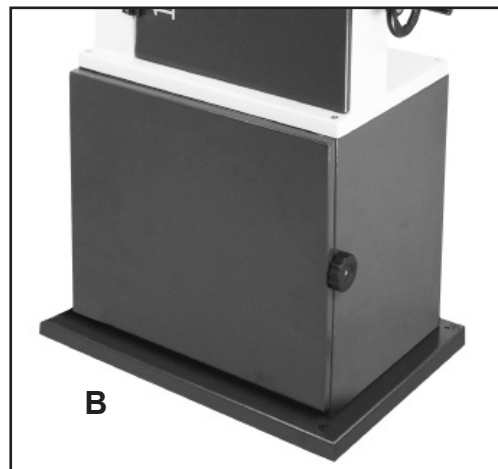

CONTINUED ON PAGE 9



# CONTENTS OF PACKAGE

## TABLE OF LOOSE PARTS continued

### Table Assembly:

- A. Table with Leveling Pin and Lanyard
- B. Rip Fence Front Rail and Hardware
- C. Table Mounting Bolts and Washers (4)

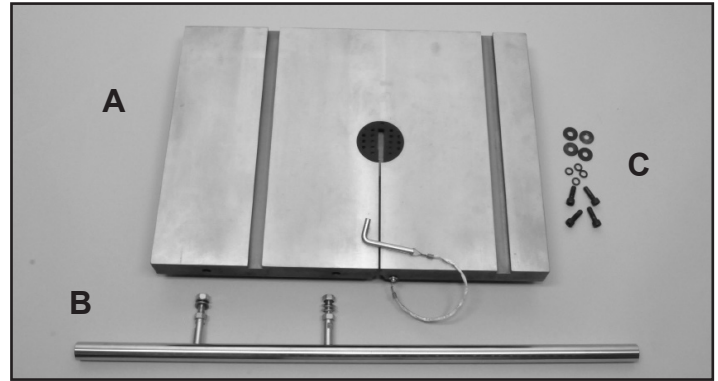

### Rip Fence Assembly & Parts:

- D. Rip Fence
- E. Resaw Bar Assembly
- F. Rip Fence Carrier Assembly
- G. Blade Tension Handle
- H. Guide Post Cap
- I. Table Leveling Bolt and Nut
- J. Push Stick and Tow Bar (in optional mobility kit)  
Mounting Bolts and Nuts (3)

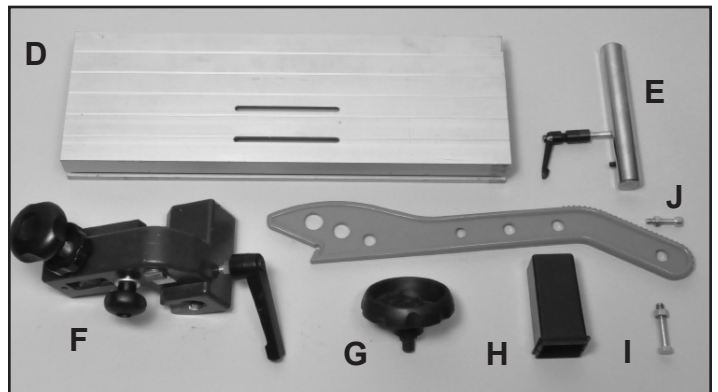

### Tools and Tool Holder:

- K. Wrenches: 10, 13, 17/19 mm
- L. Hex Wrenches; 3, 4, 5, 6 mm
- M. Tool Holder and Mounting Screws (2)

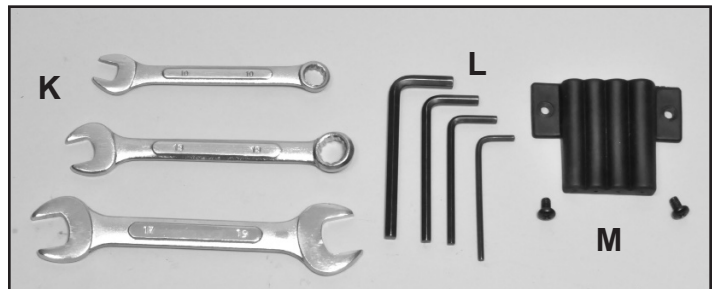

### Additional Tools required - not supplied

- #2 Phillips Screwdriver

# INSTALLATION

## MOVING & INSTALLING THE BANDSAW

**CAUTION** The bandsaw is heavy - over 210 lbs! It is best to assemble the machine near the area where it will eventually reside. When moving or positioning an assembled bandsaw, DO NOT use the table or upper blade guard assemblies as this may damage the machine. Move the bandsaw by grasping the support column and lower frame which are all welded together for rigidity. The bandsaw can also be moved by laying it down on the back/left side of the column so that the table assembly is not compromised.

1. Carefully remove the machine from the shipping carton. See above instructions on handling the saw.

2. Position the machine on a solid, level foundation that is located in an area that has ample space in front, right side and in back of the bandsaw for cutting large or long material.

For best power and safety, the bandsaw should be plugged directly into a dedicated grounded electrical outlet that is within the supplied cord length of the machine. The use of an extension cord is not recommended.

3. Align the machine so that during use, the material being cut will not face aisles, doorways, or other work areas that bystanders may be in. Do not locate or use the machine in damp or wet conditions.

4. Once in place in your shop, level the machine with spacers, and secure it to the floor with lag screws (not supplied) using the 4 holes in the cabinet base.

# STAND ASSEMBLY

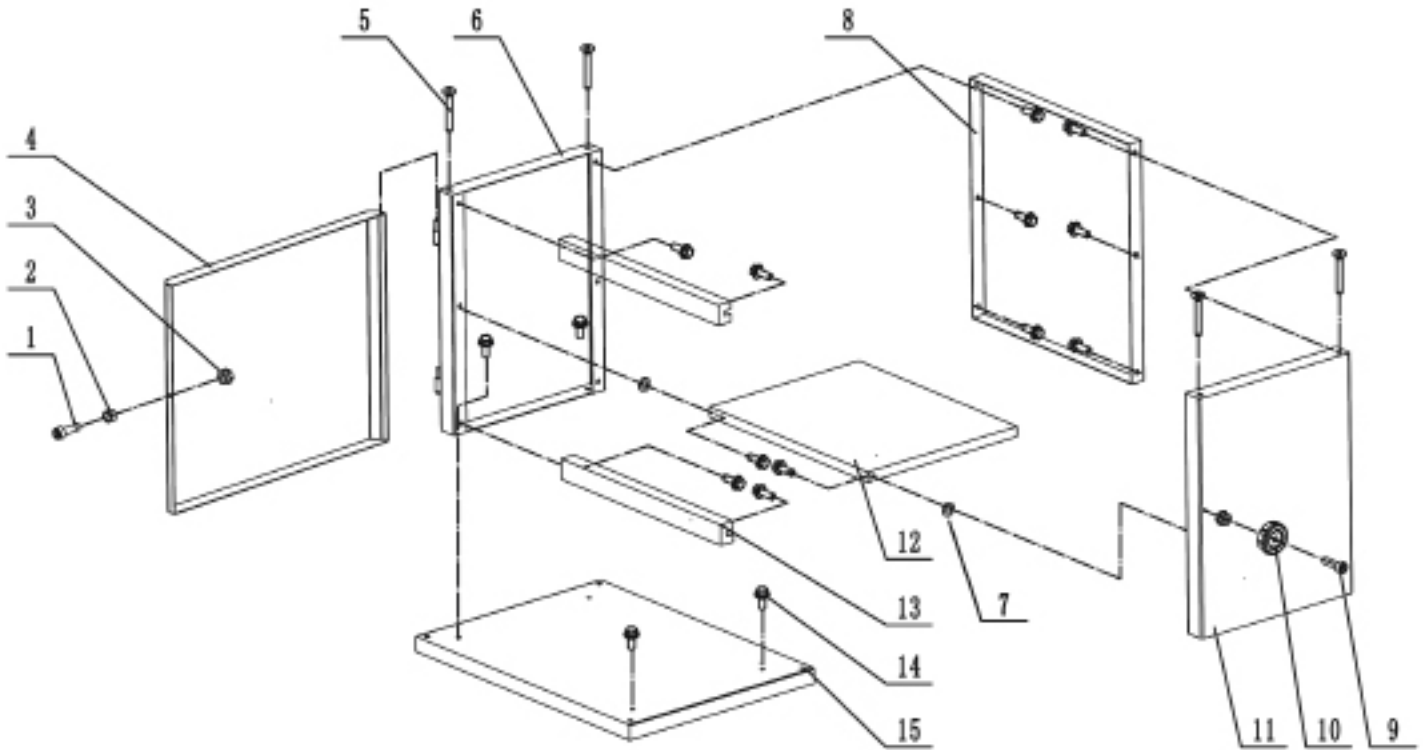

LINK TO 10-326  
ASSEMBLY VIDEO



ITEM #	DESCRIPTION	QTY	ITEM #	DESCRIPTION	QTY
1	Screw M6x16	1	9	Hex socket cap screw M6x20	1
2	Bushing	1	10	Handle	1
3	Self-locking nut M6	2	11	Right side panel	1
4	Door assembly	1	12	Shelf	1
5	Hex socket screw M6x50	4	13	Beam	2
6	Left side panel	1	14	Hex bolt with flange M8x20	16
7	Big washer	2	15	Base panel	1
8	Back side panel	1			

1. Check contents of Cabinet Stand against the parts list, and lay out parts for quick reference.
2. Install the Left Side Panel (item # 6) onto the Base Panel (15) with two Hex Socket Screws (14).
3. Install the Right Side Panel (11) on to the Base Panel (15) with two Hex Socket Screws (14).
4. Add two Hex Bolts with Flanges (14) to the front lower edges of each side panel, and leave them loose. Onto these two bolts, attach a connecting Beam (13) and fasten in place.
5. Install the Handle onto the right side panel with Hex Socket Cap Screw and Nut (9).
6. Add three Hex Bolts with Flanges (14) to the rear edges of both the Left and Right Panels, and leave them loose. Onto these six bolts slide on the Back Side Panel (8). Fasten only the top and bottom bolts, leaving the middle two bolts loose. These will be used for attaching the shelf in step 7.
7. Install a Big Washer (7) and Hex Bolt with Flange (14) to the middle holes in the front edges of both the Left and Right Panels. Onto these four, loose middle bolts, install the Shelf and tighten the bolts to secure the shelf in place.
8. Add two Hex Bolts with Flanges (14) to the front top edges of each side panel, and leave them loose. Onto these two bolts, attach the last connecting Beam (13) and fasten in place. Make sure all nuts are secure.
9. Install the Door Assembly (4) on to the left side panel by sliding its hinges onto the hinge pins.
10. Onto the right edge of the door, install the handle's locking Screw (1), Bushing (2) and Nut (3).
11. Mount the Bandsaw to the assembled Cabinet Stand with four Screws (5). This can be done in two ways; A) With assistance, lift the bandsaw and carefully position it in place on top of the stand. B) If alone, lay the bandsaw down on its column onto 4x4 wood blocks, and lay the stand also on its side on blocks to match the bandsaw height. This will allow room to install the screws. Then tilt the saw up when done.

# ASSEMBLY

**WARNING** THE MACHINE MUST NOT BE PLUGGED IN AND THE POWER SWITCH MUST BE IN THE OFF POSITION UNTIL ASSEMBLY IS COMPLETE.

**NOTE:** Parts referenced throughout the manual refer to the different sheets and key numbers of the Parts Diagrams and Parts Lists on pages 28 to 39. Example: (#1A) refers to Part #1 on Sheet A.

## TABLE ASSEMBLY

1. Remove the Table Leveling Pin (Part #4B) from the front of the table. This metal pin keeps the two sides of the table level at the slot area. Fig. 1.

2. Mount the table in place on the trunnion with the assistance of another person. The table is heavy! Do this from the rear of the machine, so that it is easier to fit the pre-installed blade through the slot in the table.

3. Attach the table to the trunnion with the four Hex Socket Cap Screws, Spring Washers and Washers (Parts #12B, 11B, 10B). Install two bolts to the right of the blade, hand tightened only. Fig. 2. Then tip the table to 45 degrees and install the two bolts to the left of the blade. Fig. 3. DO NOT fully tighten the bolts at this time. Return the table to the horizontal position.

**NOTE:** Before finally secured in position, the table can be slightly moved, left and right. Check to make sure that the table's miter gauge slot is parallel to the side of the saw blade. This will provide a true cut when ripping stock. Set a thin metal ruler against the side of the saw blade. Make sure that it is not touching the saw's teeth, which can angle the ruler. Measure the distance from one end of the ruler to the miter gauge slot. FIG. 4. Then measure the same distance from the other end of the ruler to the miter gauge slot. Compare these two measurements and angle the table as necessary until the distances are the same.

4. Once the table is aligned parallel to blade, tighten all four of the installed bolts to secure the table in place.

## INSTALL THE 90° TABLE STOP

Thread the Hex Bolt (#8B) and Nut (#7B) to the bottom of the table in the pre-bored and tapped hole. See Fig. 12, page 13. Setting the table to 90° to the blade will be done later on pages 13 & 14.

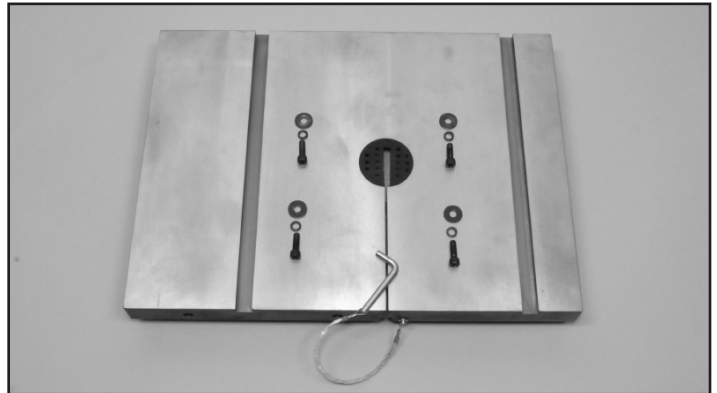

FIGURE 1

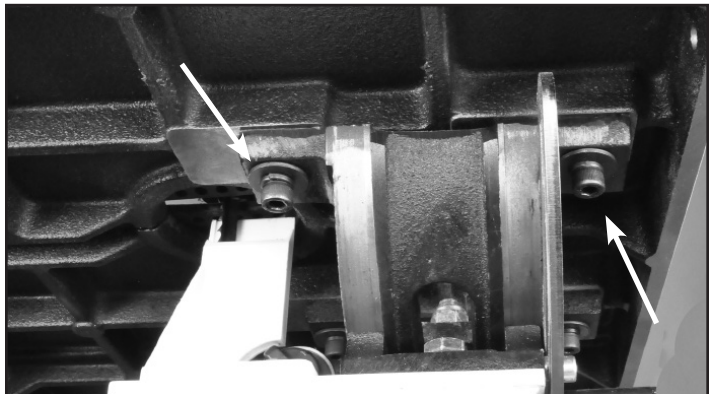

FIGURE 2

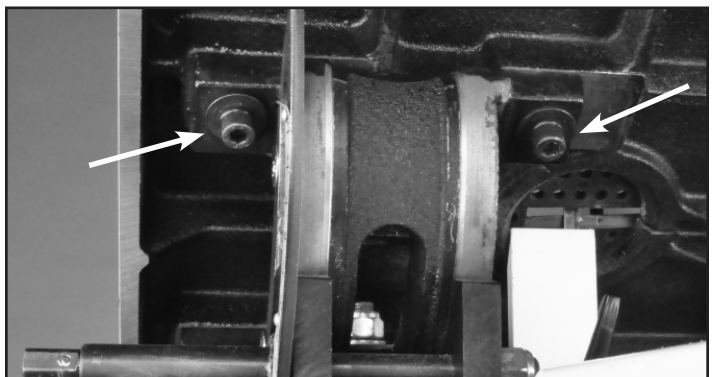

FIGURE 3

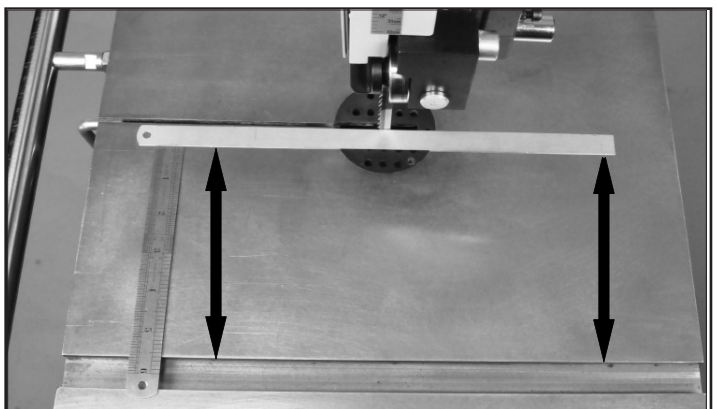

FIGURE 4



# ASSEMBLY

**⚠ WARNING** THE MACHINE MUST NOT BE PLUGGED IN AND THE POWER SWITCH MUST BE IN THE OFF POSITION UNTIL ASSEMBLY IS COMPLETE.

## RIP FENCE ASSEMBLY

1. Mount the fence Guide Rail (#12F) onto the front table edge with the two fence bar Nuts and Washers (#14F, 5F) Fig. 5. Position the bar so that it is parallel with the table surface, and equal distance out from the front edge of the table when measured at both left and right front edges of the table.



FIGURE 5

2. Slide the Fence Carrier Assembly (#9F) onto the fence's guide rail. Fig. 6.

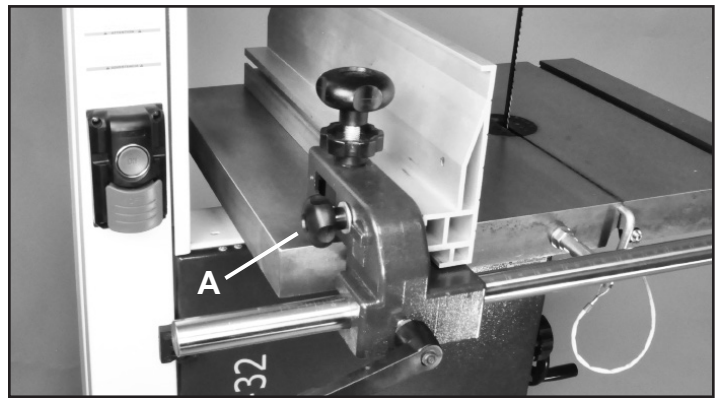

FIGURE 6

3. Slide the Rip Fence (#18F) onto the fence carrier, and lock it in place by tightening the fence lock Knob (#7F) which is located on the carrier, opposite side to the fence. Fig. 6, A.

4. With the front Locking Handle (#10F), secure the fence on the rail so that it does not move during the rest of the assembly process. Final adjustments to the fence are covered on page 19 and 20. Information on the re-saw bar is on page 22.

## INSTALL THE HAND WHEELS

1. Attach the small Handle (#24B) to the Handwheel (#23B) that tilts the table. Then install this handwheel onto the Gear Shaft (#22B) extending out from the trunnion at the back of the machine. Fig. 7, A.

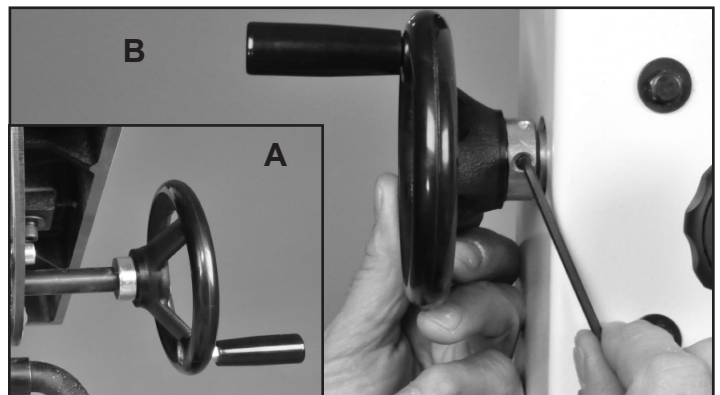

FIGURE 7

2. Attach the Handwheel (#38C) to the upper right side of the saw frame with the 5mm hex wrench. This wheel raises and lowers the blade guard. Fig. 7, B.

3. Attach the Handwheel (#26E) to the lower right side of the frame with the 5mm hex wrench. This wheel adjusts the motor drive belt tension. Fig. 7, B.

4. Install the Blade Tension Handwheel (#1D) to the top of the saw frame. No tools are needed, as the metal shaft of the handwheel has two simple pins that engage the Blade Tension Rod (#2D). Fig. 7, C.



FIGURE 8

## INSTALL THE TOOL HOLDER

1. Assemble the Tool Holder (#78A) to the column rear with two Phillips Screws (#77A). Fig. 8. Handy storage for the Hex Wrenches (3, 4, 5, 6mm).



## ASSEMBLY

### INSTALL PUSH STICK & TOW BAR HOLDERS

1. Assemble the Push Stick Hanger Bolt (#6A) and also two Bolts for the optional mobility kit's Tow Bar to the column's left side with a 5mm hex wrench. Handy storage spots when these tools are not in use. FIG. 9.



FIGURE 9



FIGURE 10

### INSTALL THE GUIDE POST CAP

1. Place Guide Post Cap (#1A) into the square hole on top of the upper frame. This cap protects the guide post assembly from falling shop dust or debris. Fig. 10.

## ADJUSTMENTS

**WARNING** THE MACHINE MUST NOT BE PLUGGED IN AND THE POWER SWITCH MUST BE IN THE OFF POSITION UNTIL ALL ADJUSTMENTS ARE COMPLETE.

### TILTING THE TABLE

1. At the rear of the saw, loosen the Quick Locking Handle (#50A) on the table trunnion by pulling it upward. Fig. 11, A.
2. Turn the table tilting Handwheel (#23B) to adjust the table to the desired angle. Fig. 11, B. Use the angle indicator scale on the trunnion bracket (C) to find the desired angle.
3. Retighten the lock handle to secure the table.



FIGURE 11

### SETTING THE TABLE SQUARE TO THE SAW BLADE'S SIDE

The table may be set at 90° to the saw blade sides by adjusting the table stop Bolt (#8B) under the table. The table stop bolt rests on the top of the pivoting Stop Block (#69A).

1. First loosen the bolt's Locking Nut (#7B) Fig. 12, A.
2. Set a square on the table and against the saw blade's flat side. Tilt the table until the table is set exactly 90° to the blade, then lock the table in position.
3. Adjust the bolt (Fig. 12, B), up or down, until it is in contact with the pivoting Table Angle Stop Block (#69A) Fig. 12, C. Retighten the locking nut making sure that the table angle setting is maintained.

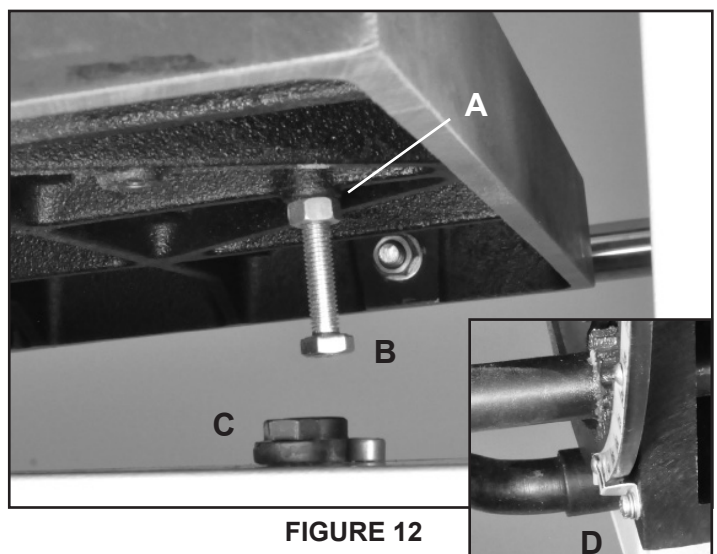

FIGURE 12

4. The angle indicator on the trunnion, under the table, can be adjusted by loosening the Phillips head screw and moving the pointer into position. Fig. 12 D.



# ADJUSTMENTS

## SETTING THE TABLE SQUARE TO THE SAW BLADE'S BACK

While pre-set before shipping, if needed, the table may also be re-set at 90° to the back of the saw blade by adjusting the trunnion micro adjustment screws.

1. On the lower Trunnion Support (#17B), slightly loosen the two Hex Bolts (#13B) that hold the support to the bandsaw frame. Fig. 13, A.
2. Set a square on the table and against the saw blade's back, flat edge.
3. Using the 3mm hex wrench, turn the rear trunnion micro adjusting hex screws (#16B) to adjust the table position. Fig. 13, B.
  - *Clockwise* will raise the trunnion & table.
  - *Counterclockwise* will lower the trunnion & table.
4. Check the table and blade angle for 90° and when achieved, re-tighten the bolts to secure the table in position.

**⚠ WARNING** THE MACHINE MUST NOT BE PLUGGED IN AND THE POWER SWITCH MUST BE IN THE OFF POSITION UNTIL ALL ADJUSTMENTS ARE COMPLETE.

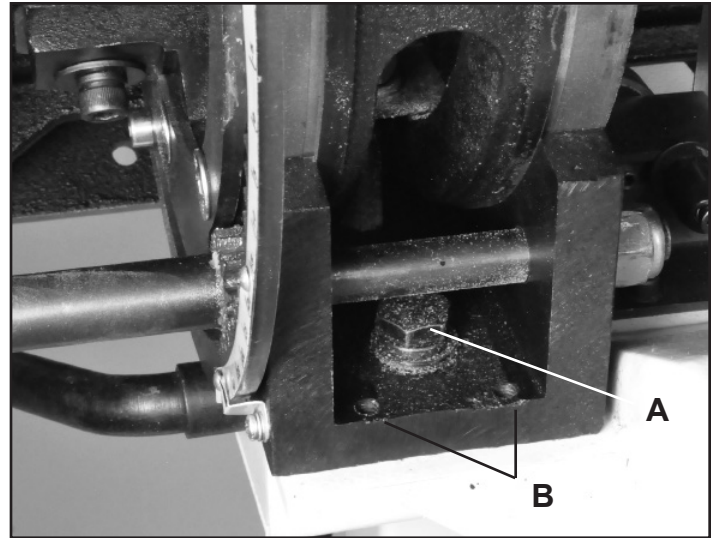

**FIGURE 13**

Photo of the micro adjusting screws shown with table angled for clarity.

## TRACKING THE SAW BLADE

**⚠ WARNING** Unplug the bandsaw. A blade is installed at the factory. It is recommended to check the blade tracking prior to use. Make sure the upper and lower blade guides are adjusted away from the blade and the tension scale is set to correspond to the width of the blade you are using.

1. Open both doors. At the rear of the machine, loosen the Lock Lever (#22D, FIG. 14, A) by turning it counterclockwise.
2. Turn the Blade Tracking Handle (#23D, Fig. 14 B) clockwise or counterclockwise, while at the same time carefully turning the Upper Wheel (#24E) by hand. Fig. 15. Check the tracking of the blade on the wheel through the side window (C). Make at least three rotations of the wheel or until the blade tracks centered on the wheel.
3. Once the blade runs centered, tighten the lock lever and close the doors. For tracking of the blade on the Lower Wheel (#13E), see page 26 for instructions. **NOTE:** the lower wheel has been pre-set at the factory and any changes made to this wheel should be after thorough reading and understanding of the instructions. Failure to do so could damage the machine.

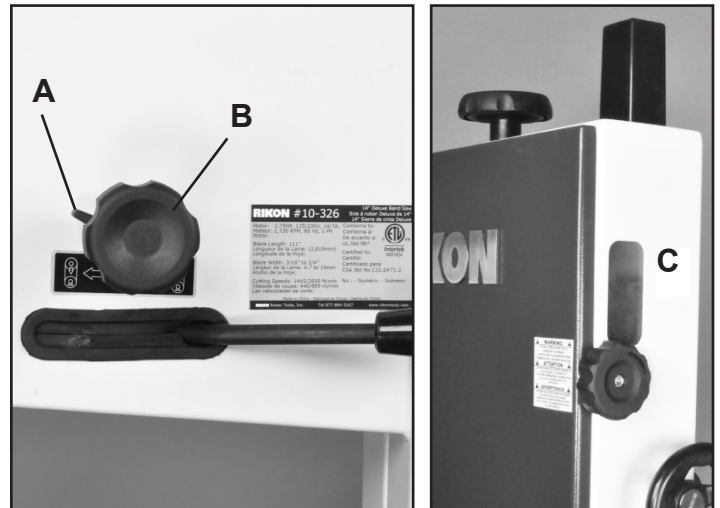

**FIGURE 14**

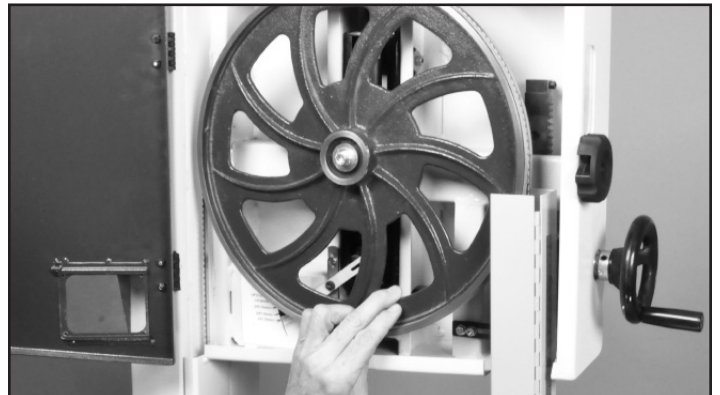

**FIGURE 15**

# ADJUSTMENTS

## ADJUSTING THE BLADE TENSION

**CAUTION** Always tension the blade with the Quick Release Lever (#17D) in the “ON” position. Failure to do so could result in lack of blade tension or tension failure. Figure 16.

**NOTE:** Release / turn ‘OFF’ the Tension Lever only to change the blade, or to prolong the life of the blade when the saw is not in use for extended periods.

1. To adjust the blade tension, turn the Blade Tension Handwheel (#1D, Fig. 17) on the top of the saw.

To tighten the tension of the blade, turn the hand wheel clockwise. Tension the blade until the Tension Indicator Arrow (#19A, Fig. 19) corresponds to the width of blade you are using. View the indicator Arrow through the top door’s front window. Fig. 18.

**NOTE:** The blade tension scale may read differently due to different blade specifications from manufacturers - steel thickness, material, or variations in the welded blade length. It may be necessary to adjust the tension arrow up/down one size on blade tension scale to match your blade. Note the blade setting for the next time the same blade is used.

See page 16 for information on ‘Adjusting the Blade Tension Stop’ for tensioning blades that are welded a bit longer than the specified 111” length.

**General Rule** for blade tension: With the saw unplugged and the blade guard up, the saw blade should deflect about 1/4” when pressed with a finger to the side of the blade.

## ADJUSTING THE BLADE TENSION INDICATOR

The Blade Tension Indicator Arrow (#19A, Fig. 19,A) should be checked and adjusted the first time the saw is set up and run, and whenever a new blade is installed.

The blade tension indicator should be adjusted for blades made from thicker steel, if over cut or undercut in length, or made by different manufacturers.

1. With moderate tension on the blade, loosen the adjusting Screw (#17A) with a Phillips-head screw driver (Fig. 19, B).

2. Adjust the blade indicator up/down as needed and then re-tighten the adjusting screw.

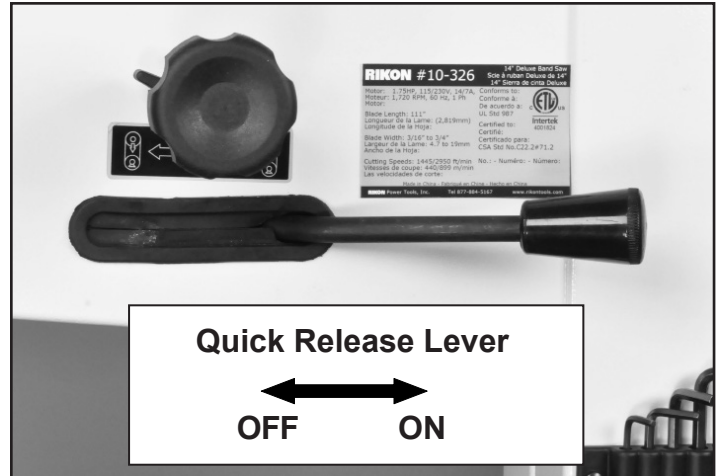

FIGURE 16



FIGURE 17

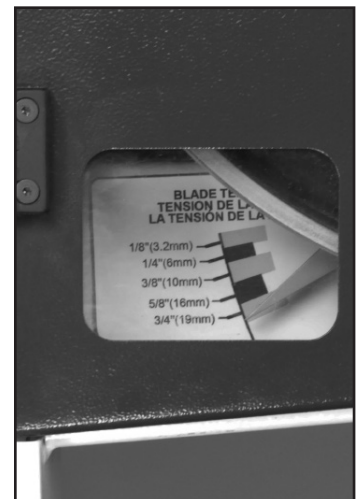

FIGURE 18

**WARNING** THE MACHINE MUST NOT BE PLUGGED IN AND THE POWER SWITCH MUST BE IN THE OFF POSITION UNTIL ALL ADJUSTMENTS ARE COMPLETE.

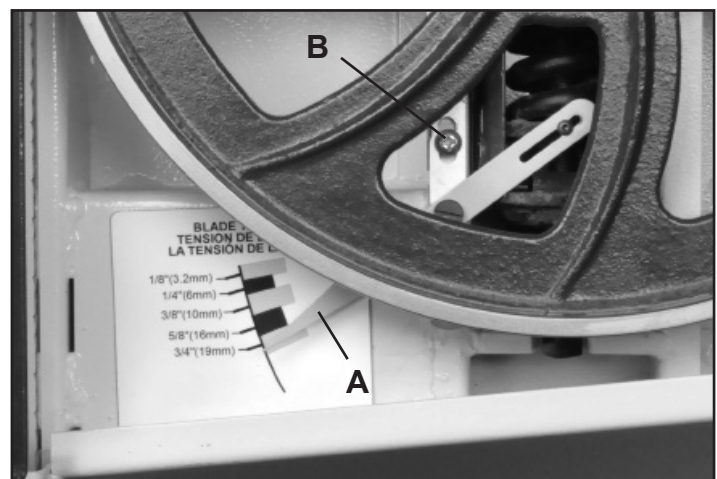
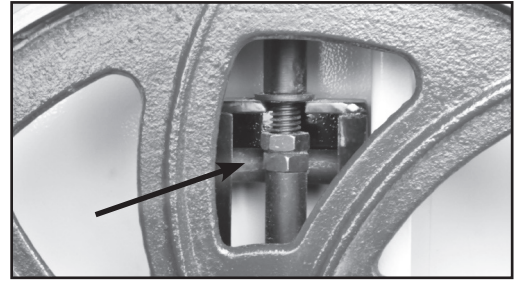

FIGURE 19

# ADJUSTMENTS

## ADJUSTING THE BLADE TENSION STOP

If you can not set full tension on a new blade, the blade is most likely welded a bit longer than the standard 111" length, and so just beyond the pre-set tensioning range of the saw. To fix this, behind the top bandsaw wheel is the threaded Blade Tension Rod (#2C). Loosen the Nuts (#3C) and screw them upward about 1/4", then retighten. This will increase the blade tensioning range of the saw for your new blade.



## CHANGING THE BANDSAW BLADE

**WARNING** Unplug the machine from the electrical supply. This ensures that the Bandsaw will not accidentally turn on if the ON/OFF switch is bumped.

1. Open the top and bottom wheel doors.
2. Release the blade tension by moving the quick release lever from right to left. Fig. 20.
3. Open the Hinged Door (#11C) on the blade guard by loosening the Locking Handle (#14C). Fig. 21, A.
4. Remove the saw blade from the top wheel then feed it through the upper blade guides (B), slot in the table (C), lower blade guides & lower blade guard (D), out of the slot in the column of the machine (E), off of the bottom wheel, and then around the front rail (F).

**CAUTION** Be careful not to cut yourself on the sharp saw teeth. Wear gloves for protection.

5. When installing the new blade, reverse the steps 1-4 above. Ensure that the blade teeth are pointing downwards and towards you at the position where the blade passes through the table.
6. Center the blade on both wheels.
7. Re-tension the new blade by moving the quick release lever back to the ON position, Fig. 20, and check the blade tracking. The blade should run in the center of the wheels. Refer to "Tracking the Saw Blade" on page 14 for more details.
8. Reset the blade guides as described in the section "Adjusting the Blade Guides" on pages 17 and 18.
9. Reset the blade tension as described in the section "Adjusting the Blade Tension" on page 15.
10. Close the hinged door on the blade guard and tighten the locking handle to keep the door closed.
11. Close and lock both the wheel doors before reconnecting the power supply.

**WARNING** THE MACHINE MUST NOT BE PLUGGED IN AND THE POWER SWITCH MUST BE IN THE OFF POSITION UNTIL ALL ADJUSTMENTS ARE COMPLETE.



FIGURE 20

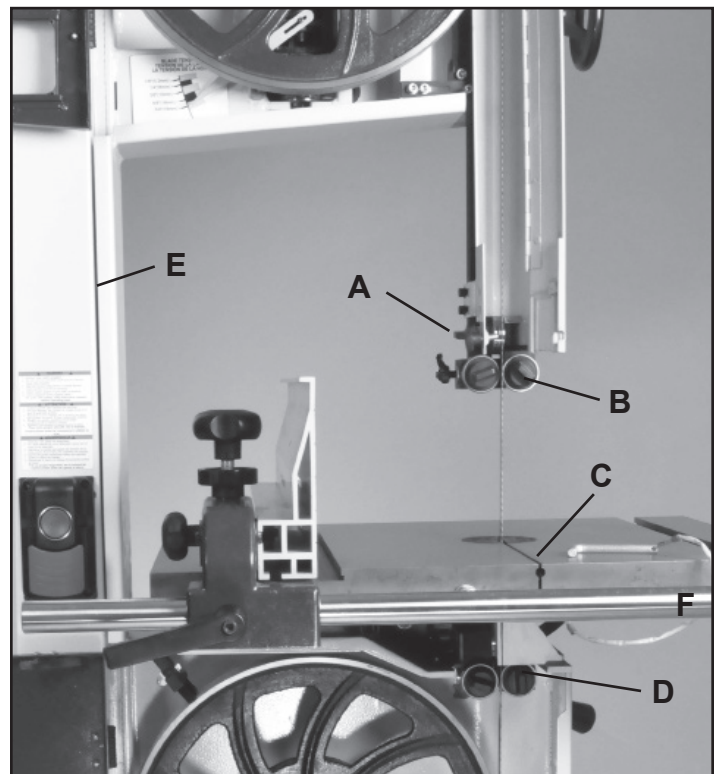

FIGURE 21



# ADJUSTMENTS

## ADJUSTING THE BLADE GUIDES

The 10-326 Bandsaw features quick-adjusting, spring loaded, ball bearing blade guides for fast and easy setting to the blades. With the bandsaw blade properly centered on the drive wheels, the guide bearings can then be set. To adjust the blade guides:

### Upper Guides:

1. Position the right and left roller guides relatively close to the blade. First, loosen their front Lock Handles (#21C, Fig 22, A). The Guide Shafts (#25C) that hold the guide bearings are spring loaded! To move the guides towards the blade, simply push the ends of the guide shafts (B), or use the front lock handles to pull the guides towards the blade. Lock the guides in place. Fig. 22.

2. The guides should be approximately 1/16" behind the gullets of the saw blade. If they need to be moved, loosen the back Clamp Handle (#31C, Fig. 23, C) and move the Upper Guide Block (#20C, D) that holds the guides so that the guides are properly positioned behind the blade gullets. Re-tighten the handle when done. Fig. 23.

3. Set both bearing guides to within 1/32" of the saw blade - about the same thickness of a business card. Do not set the bearing guides too close, or touch the sides of the blade, as this will adversely affect the life of the saw blade and bearings.

4. Adjust the rear bearing guide (Fig. 24, E) to be just clear of the back of the saw blade. Release the guide's Locking Handle (#17C, F) and move the rear guide towards the blade by pushing the end of the Rear Guide Shaft (#27C, G). Tighten the handle when done. Fig. 24.

### Lower Guides:

Adjusting the lower ball bearing guides, that are below the table, is similar to the steps taken for the upper guides.

1. Position the right and left roller guides close to the blade. Loosen the front Lock Handles (#38A, Fig. 25, A). Move the guides towards the blade by pushing the ends of the Guide Shafts (#42A, B), or use the front lock handles to pull the guides towards the blade. Lock the guides in place. Fig. 25.

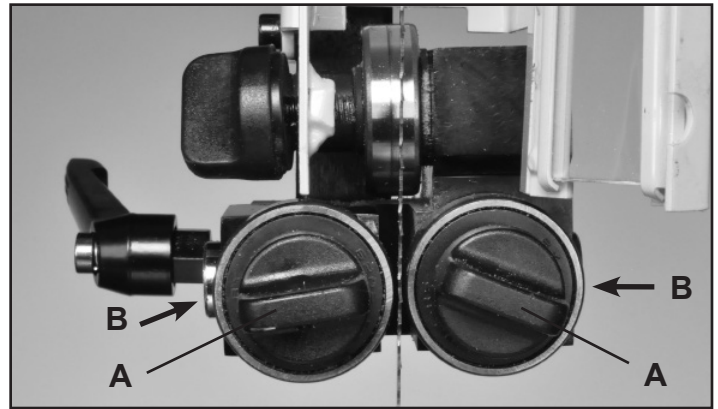

FIGURE 22

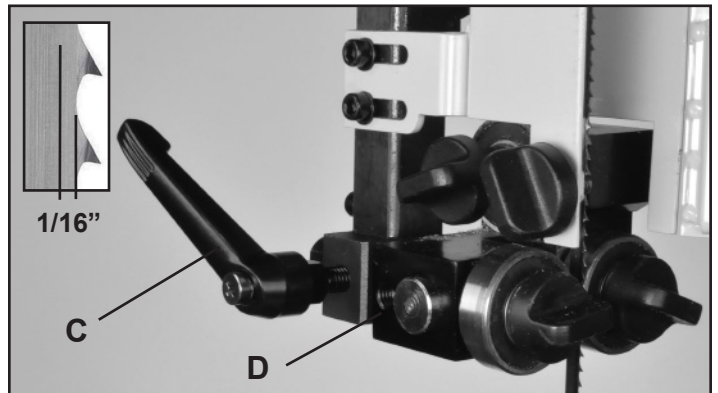

FIGURE 23

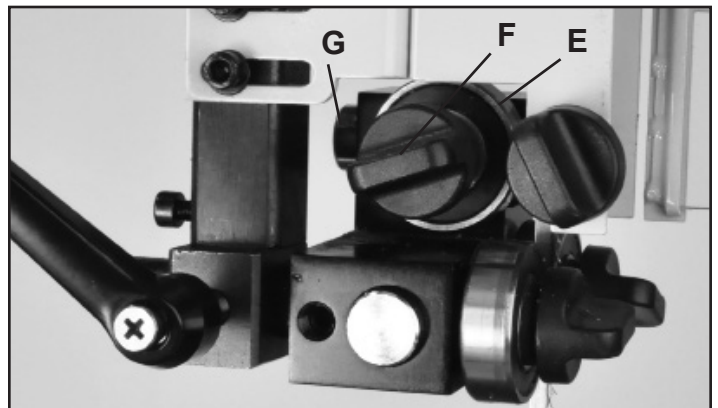

FIGURE 24

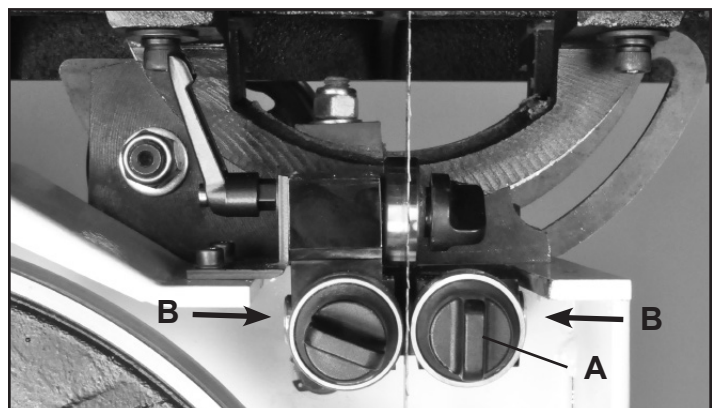

FIGURE 25 NOTE: Blade Guard removed for photo purposes

CONTINUED ON PAGE 18

# ADJUSTMENTS

## ADJUSTING THE BLADE GUIDES - continued

### Lower Guides - continued:

2. The guides should be approximately  $1/16$ " behind the gullets of the saw blade. If they need to be moved, loosen the Lever Handle (#60A, Fig. 26, A), located to the left of the Lower Guide Block (#43A, B), and move this block that holds the guides so that the guides are properly positioned behind the blade gullets. Re-tighten the lever handle when done.

3. Set both bearing guides to within  $1/32$ " of the saw blade - about the same thickness of a business card. Do not set the bearing guides too close, or touch the sides of the blade, as this will adversely affect the life of the saw blade and bearings.

4. Adjust the rear bearing guide to be just clear of the back of the saw blade. Release the guide's Locking Handle (Fig. 27, C) and move the rear guide towards the blade by pushing the end of the Rear Guide Shaft (#45A, D), or use the lock handle to pull the guide towards the blade. Tighten the handle when done.

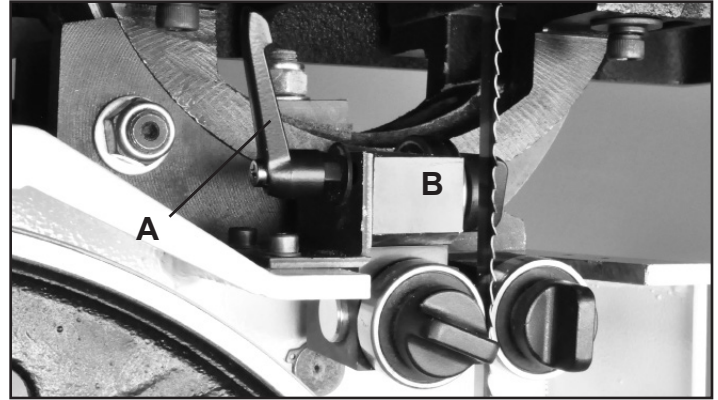

FIGURE 26 NOTE: Blade Guard removed for photo purposes

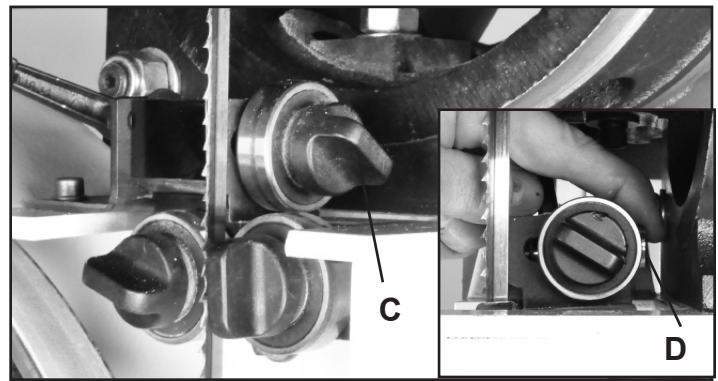

FIGURE 27 NOTE: Blade Guard removed for photo purposes

## ADJUSTING THE BLADE GUIDE & GUARD

**NOTE:** Before cutting, set the upper guide bearings approximately  $1/4$ " above the top surface of the work piece. This will give the best blade control. Fig. 28.

1. Loosen the Guidepost Lock Knob (#1C, Fig. 30A) and turn the Guidepost Handle (#38C, Fig. 29, B) to raise or lower the guide post/upper blade guide assembly to the desired height. A measurement scale has been supplied on the right side of the guide post for quick reference on the height of the guide bearings above the table surface.

2. When the guide bearings are in proper position, re-tighten the guidepost lock knob.

**NOTE:** The guide post is pre-set at the factory to aligned vertical with the bandsaw blade. If the guide post setting ever needs slight adjustment:

3. Open the top door and lower the blade guard all the way down to the table to access the Guide Bracket (#4C). Fig. 31.

4. Loosen the four Hex Bolts (#2C) located at the rear of the top frame. Fig. 30, C). This will allow the

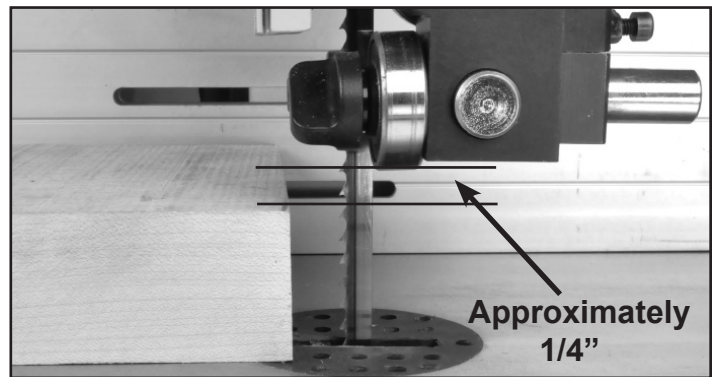

FIGURE 28

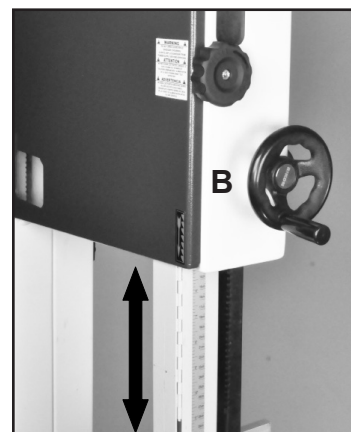

FIGURE 29

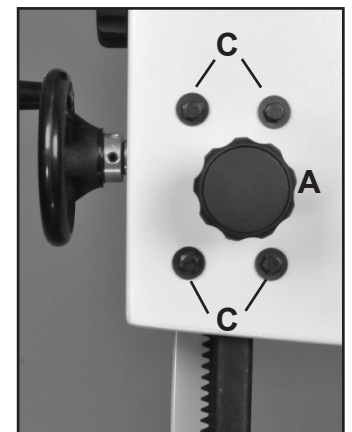

FIGURE 30

CONTINUED ON PAGE 19



# ADJUSTMENTS

## ADJUSTING THE BLADE GUARD - continued

guide post to be shifted/angled a bit left or right to correct any positioning issues.

5. There are also four Set Screws (#5C) set in the rear of the guide bracket near the corners. If the guard post needs to be angled slightly towards the front or back of the table, or even twisted on an angle, make the adjustment with these screws. Fig. 31.

- Advancing the top two set screws will angle the post towards the rear of the table.
- Advancing the bottom two set screws will angle the post towards the front of the table.
- Setting the two left or right screws will angle the post to the right or left.

6. When the post is adjusted vertical, tighten the four hex bolts that were loosened in step 4.

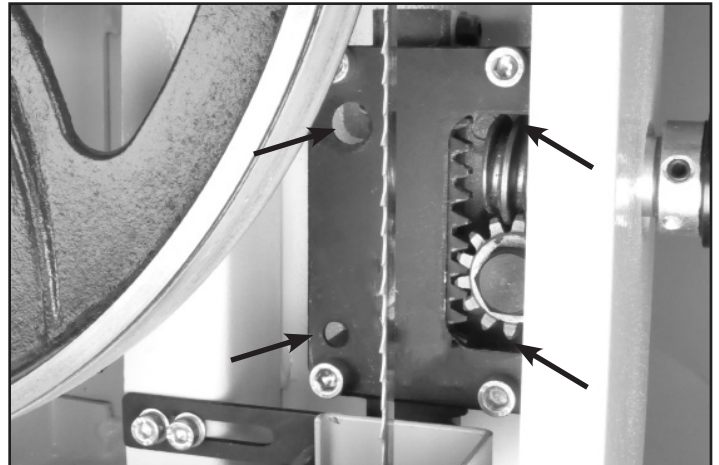

FIGURE 31



**WARNING** THE MACHINE MUST NOT BE PLUGGED IN AND THE POWER SWITCH MUST BE IN THE OFF POSITION UNTIL ALL ADJUSTMENTS ARE COMPLETE.

## ADJUSTING THE RIP FENCE FOR DRIFT

The 10-326 Bandsaw features an innovative fence system that will easily adjust to eliminate 'drift', and bring the fence back to being parallel to the blade. Plus, it allows quick changing of the fence from a vertical to horizontal position, or for use to the left or right of the blade. To adjust the fence for drift:

1. Loosen the side Handle (#7F, Fig. 32, A) which holds the rip fence against the Fence Carrier (#9F, B).
2. Loosen the Locking Knob (#2F, Fig. 32, C).
3. Turn the top Adjusting Handle (#1F, D) to position the fence left or right as needed to align it parallel to the blade and miter saw slots in the table. The handle turns a Cam (#4F, E) that presses against the fence and pivots it as needed.
4. Once the fence is set, tighten the Handle and Knob that were loosened in steps 1 and 2.

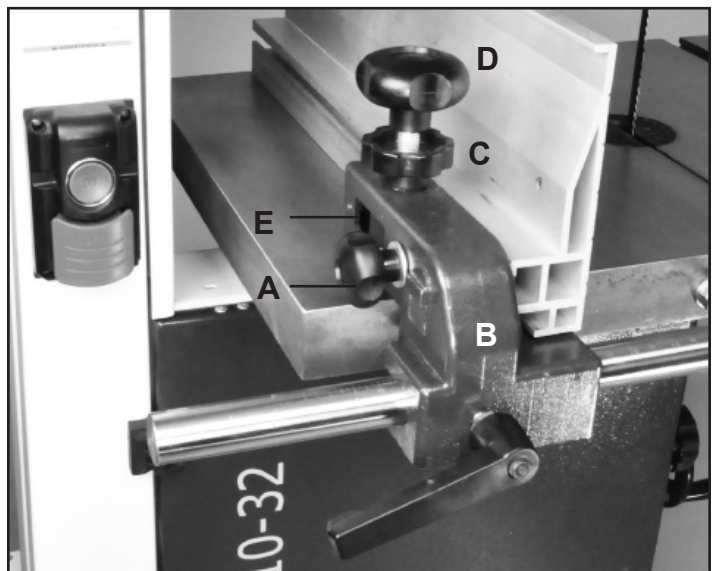

FIGURE 32

## ADJUSTING THE FENCE 90° TO THE TABLE

Check that the fence is 90 degrees to the table using a suitable square. If adjustments are required, raise or lower either side of the fence's Guide Rail until the fence body is 90 degree to the table. Once set at 90 degrees, fully tighten the fence bar nuts. FIG. 33. See page 12 for the guide rail installation process.

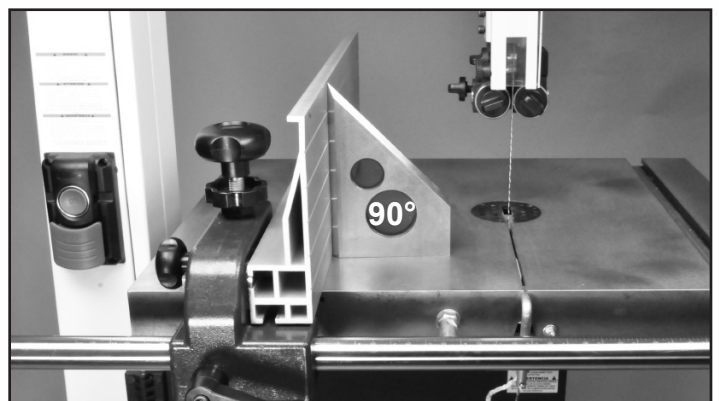

FIGURE 33

# ADJUSTMENTS

## ADJUSTING THE FENCE TO THE TABLE

Check that the fence is lying flat or parallel to the table surface. The gap between the table and the bottom of the fence should be equal along the whole length of the fence. The rear, bottom of the fence includes a Nylon Plate (#23F) that helps in sliding the fence over the table. A small gap between the fence and table results from this plate. Fig. 34.

If there is a sizeable gap, refer to page 12 for the mounting and re-positioning of the front fence rail.

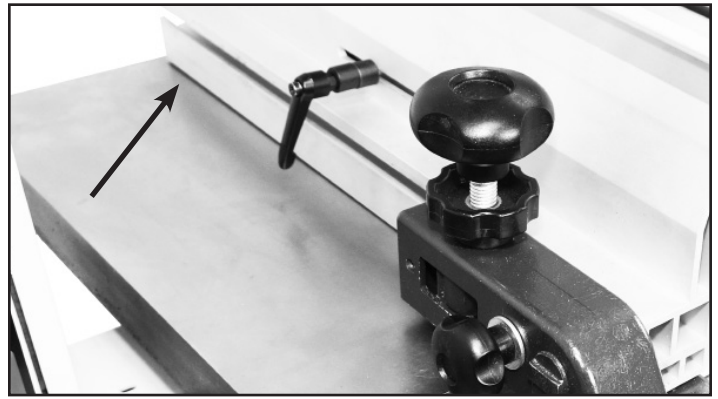

FIGURE 34

## ADJUSTING THE FENCE ON THE CARRIER

The fence can be changed from a vertical position to a horizontal position, or from its mounting on the left side of the blade to the right with simple adjustments of the carrier's handles and hardware.

### To change the fence from vertical to horizontal:

1. Loosen the side Handle (#7F, Fig. 35, A) which holds the rip fence against the Fence Carrier (#9F, B).

2. Slide the fence forward to remove it from the carrier's Sliding Block (#11F, Fig. 35, C).

3. Turn the fence down to its horizontal position and slide it back onto the carrier. The bottom of the fence is slotted to mount on the sliding block, and position itself on the small, raised key on the side of the carrier. Fig. 36, D.

4. Once in place, retighten the side handle to secure the fence in position on the carrier.

5. Check the fence for drift, and make corrections if needed per instructions on page 19.

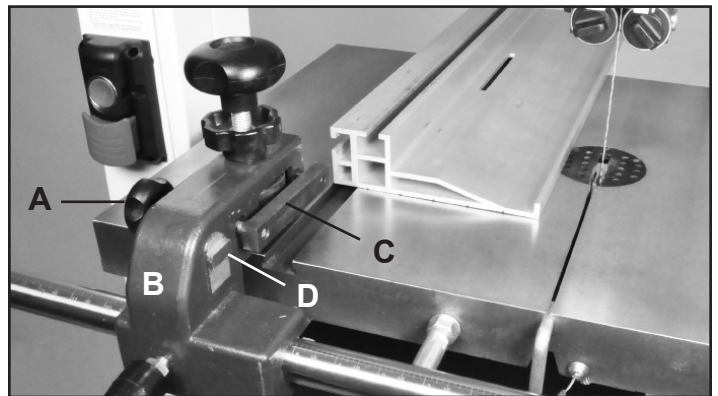

FIGURE 35

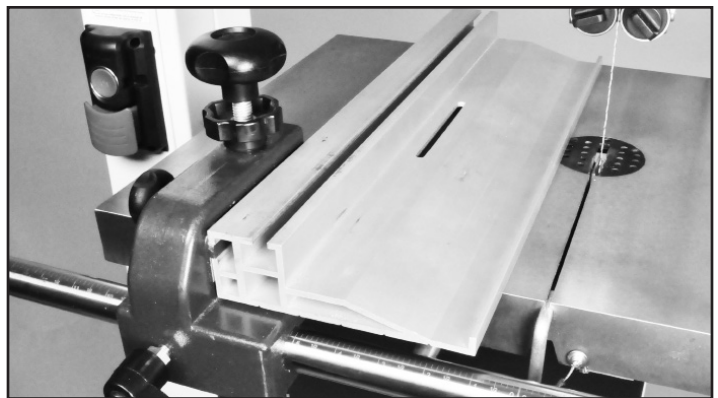

FIGURE 36

### To change the fence from the left side of the carrier to the right side for using the rip fence to the right of the blade:

1. Loosen the side Handle (#7F, Fig. 35, A) which holds the rip fence against the Fence Carrier (#9F, B).

2. Slide the fence forward to remove it from the carrier's Sliding Block (#11F, C). Move the carrier on the front rail to the right side of the table and blade.

3. Fully unscrew the side handle from the sliding block and reassemble the parts on the opposite, left

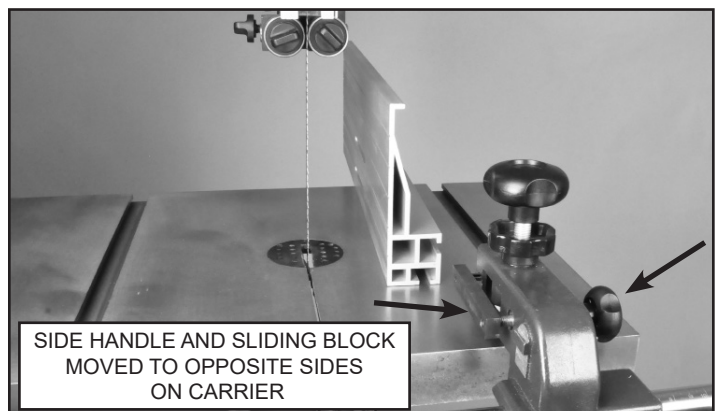

FIGURE 37

CONTINUED ON PAGE 21

# ADJUSTMENTS

side of the carrier. Then rotate the fence 180° end-to-end and slide it back onto the carrier. Fig. 37 & 38.

4. Once in place, retighten the side handle to secure the fence in position on the carrier. Fig. 38.

5. Check the fence for drift, and make corrections if needed per instructions on page 19.

**⚠ WARNING** THE MACHINE MUST NOT BE PLUGGED IN AND THE POWER SWITCH MUST BE IN THE OFF POSITION UNTIL ALL ADJUSTMENTS ARE COMPLETE.

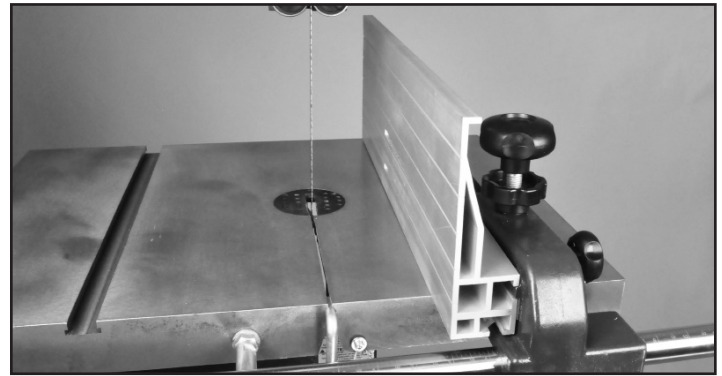

FIGURE 38

## CHANGING THE BLADE SPEED

This Bandsaw has two blade speeds, high speed (2950 ft/min) and low speed (1445 ft/min). **NOTE:** The bandsaw is shipped in the high speed mode.

The lower wheel has two integral “multi-vee” form pulleys, and the motor shaft has a twin multi-vee form pulley. The “multi-vee” belt passes around the wheel pulley and the motor pulley. The belt tension is released and applied by using the Handwheel (#26E) Fig. 39, A.

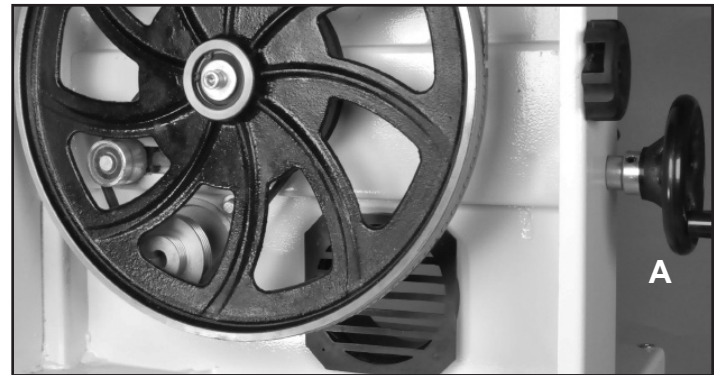

FIGURE 39

For the *HIGH SPEED* (2950 ft/min), the belt should be installed on the rear pulley of both the motor and the wheel, as shown in Fig. 40.

The high speed setting is the standard for all around sawing needs of woods and composites.

For the *LOW SPEED* (1445 ft/min), the belt should be installed on the front pulley of both the motor and wheel, as shown in Fig. 40.

The low speed setting is best for cutting extra hard material - wood, plastics, and non-ferrus metals. The correct blade type is necessary for clean, effective cutting action in these materials.

## ADJUSTING THE DRIVE BELT TENSION

To adjust the belt tension turn the lower Handwheel (#26E, Fig. 39, A) until there is about 3/8” to 1/2” deflection in the “multi-vee” drive belt. **DO NOT** over tension the belt as this can put excessive, damaging pressure on the belt, pulleys and motor. Fig. 41.

**SEE PAGE 25 FOR INSTRUCTIONS ON CHANGING THE DRIVE BELT.**

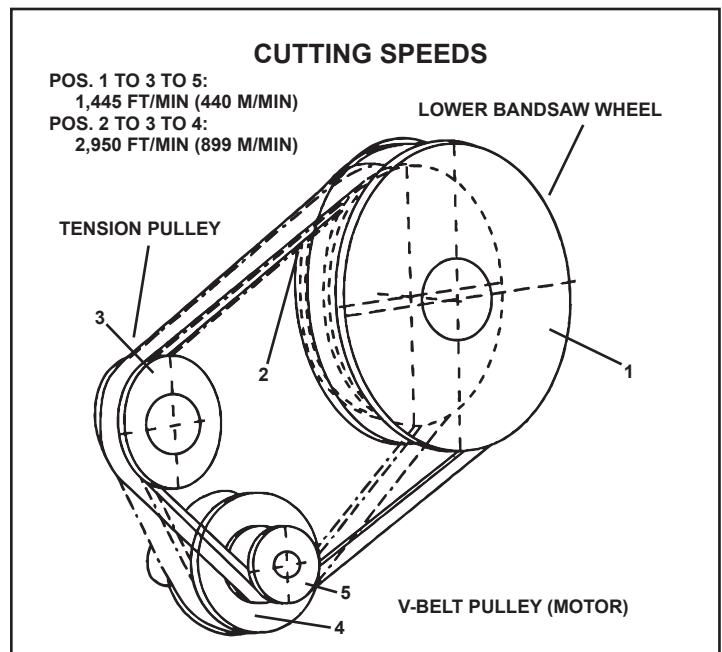

FIGURE 40

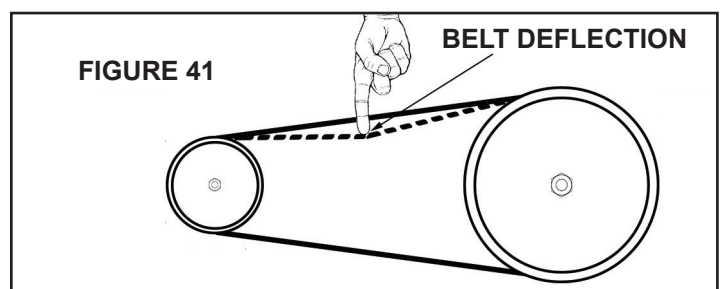

FIGURE 41



## ADJUSTMENTS

### ON/OFF SWITCH

To operate the saw, Press the top, round 'ON' button in to its full depth to turn the saw on. There should be a 'click' to indicate the 'ON' contact is made.

Once work is finished, hit the bottom red safety paddle switch to turn the saw 'OFF'. Fig. 42.

If the saw is not to be used for an extended length of time, unplug the saw from the power supply and release the tension on the blade.

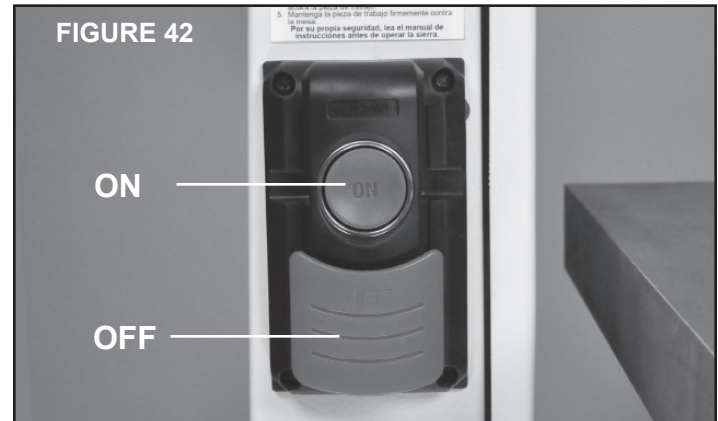

## OPERATION

### BASIC OPERATION

The blade cuts on a continuous down-stroke. Never start the saw with the workpiece in contact with the blade.

With both hands, firmly hold the workpiece down on the table, and feed it slowly towards the blade, putting only light pressure on it, and keeping your hands away from the blade.

Keep your hands and fingers away from the blade. Use a push stick whenever working close to the blade.

For best results, the blade must be sharp. A dull blade will not cut correctly, especially when straight cutting, and causes excess pressure to be applied on the rear guide bearings.

Select the right blade for the job, depending on the thickness of the wood and the cut to be made. The thinner and harder the wood, the finer the teeth of the blade should be. Use a fine tooth blade for cutting sharp curves. See page 40 for more information on blades.

The machine is especially suited for cutting curves, but will also make straight cuts. When cutting, follow the design marked out by pushing and turning the workpiece evenly into the blade.

Do not attempt to turn the workpiece without pushing it, as this may cause the workpiece to get stuck, or bend the blade. For straight cuts, use the fence provided to feed the workpiece along the blade slowly and in a straight line. Use the re-saw bar for thick or difficult woods. Use a miter gauge for cross-cut or angle cutting.

See page 6 for more operation information.

### RE-SAWING

A re-saw guide bar is supplied to help correct any blade wandering during certain re-sawing operations.

For re-sawing, attach the re-saw bar to the slot on the fence. Position the re-saw bar so that it is aligned with the front of the blade. Draw a reference line down the workpiece. Use the bar as a pivot point, angling the wood left or right while against the bar, to follow the line through the cut. Fig. 43.

**Note:** The re-saw bar is not needed for all re-saw operations. Proper blade tension and selection, as well as proper guide set up, will allow re-sawing flat stock against the fence without the use of the re-saw bar.

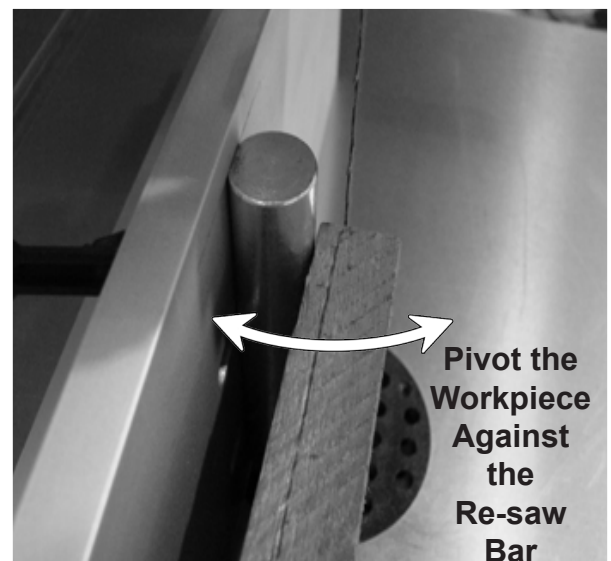

FIGURE 43

# MAINTENANCE

**CAUTION** BEFORE CLEANING OR CARRYING OUT MAINTENANCE WORK, DISCONNECT THE MACHINE FROM THE POWER SOURCE (WALL SOCKET). NEVER USE WATER OR OTHER LIQUIDS TO CLEAN THE MACHINE. USE A BENCH BRUSH. DO NOT USE COMPRESSED AIR NEAR BEARINGS. REGULAR MAINTENANCE OF THE MACHINE WILL PREVENT UNNECESSARY PROBLEMS.

1. Keep the table clean to ensure accurate cutting.
2. Keep the outside of the machine clean to ensure accurate operation of all moving parts and prevent excessive wear.
3. Keep the ventilation slots of the motor clean to prevent it from overheating.
4. Keep the inside of the machine (near the saw blade, etc.) clean to prevent accumulation of dust. Use dust collection, if possible.
5. To prolong the life of the blade, when the bandsaw is not in use for extended periods, release the blade tension. Before reusing the bandsaw, ensure that the blade is re-tensioned and tracking is checked.
6. Keep the guide bearings free of dust, and clean the guide bearing assemblies frequently.

# WIRING DIAGRAM

**WARNING:** This machine must be grounded. Replacement of the power supply cable should only be done by a qualified electrician. See page 5 for additional electrical information.

As received from the factory, your bandsaw is ready to run at 115V operation. It can be switched to 230V according to the schematic and instructions below. Note the warning for disabling the electrical outlet.

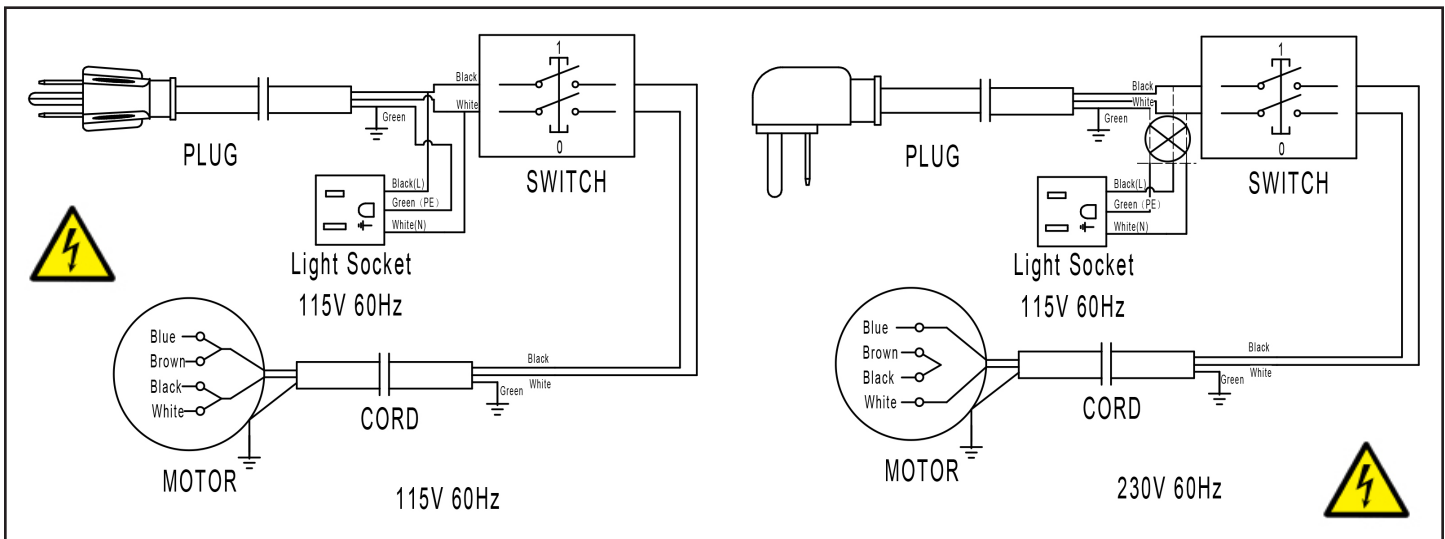

**For 115V wiring;** connect the black & white motor terminal wires to the black switch wire lead, and connect the blue & brown terminal wires to the white switch wire lead. Disregard the wires that lead to the capacitor.

**For 230V wiring;** tie the black & brown terminals together, connect the white motor terminal wire to the black switch wire lead, and connect the blue motor terminal wire to the white switch wire lead. Disregard the wires that lead to the capacitor.

**WARNING:** For 220V wiring, DISCONNECT the wires leading to the Power Outlet to make it inoperable. This plug is for 115V wiring only.



# TROUBLESHOOTING



## WARNING

**FOR YOUR OWN SAFETY, ALWAYS TURN OFF AND UNPLUG THE MACHINE BEFORE CARRYING OUT ANY TROUBLESHOOTING.**

TROUBLE	PROBABLE CAUSE	REMEDY
The machine does not work when switched on.	<ol style="list-style-type: none"> <li>1. No power supply.</li> <li>2. Defective switch.</li> </ol>	<p>Check the cable for breakage. Contact your local dealer for repair parts.</p>
The blade does not move with the motor running.	<ol style="list-style-type: none"> <li>1. The quick release lever or blade tension handwheel has not been tightened.</li> <li>2. The blade has come off one of the wheels.</li> <li>3. The saw blade has broken.</li> <li>4. The drive belt has snapped.</li> </ol>	<p>Switch off the motor, tighten the quick release lever or blade tension handwheel. Open the hinged door and check. Replace the blade. Replace the belt.</p>
The blade does not cut in a straight line.	<ol style="list-style-type: none"> <li>1. Fence for cutting not used.</li> <li>2. Too fast feed rate.</li> <li>3. The blade teeth are dull or damaged.</li> <li>4. Blade guides not suitably adjusted.</li> </ol>	<p>Use a fence. Put light pressure on the workpiece &amp; make sure the blade does not bend. Use a new blade. Adjust the blade guides (see the section on pages 17 and 18).</p>
The blade does not cut, or cuts very slowly.	<ol style="list-style-type: none"> <li>1. The teeth are dull, caused by cutting hard material or long use.</li> <li>2. The blade was mounted in the wrong direction.</li> </ol>	<p>Replace the blade, use a 6 T.P.I. blade for wood and soft materials. Use a 14 T.P.I. blade for harder materials. A 14 T.P.I. blade always cuts slower due to the finer teeth. Install the blade correctly.</p>
Sawdust builds up inside the machine.	<ol style="list-style-type: none"> <li>1. This is normal</li> </ol>	<p>Clean the machine regularly. Open the hinged door and remove the sawdust with a vacuum cleaner. Attach a dust collection system.</p>
Sawdust inside the motor housing.	<ol style="list-style-type: none"> <li>1. Excessive dust build-up on the machine exterior components.</li> </ol>	<p>Clean the ventilating slots of the motor with a vacuum cleaner. From time to time remove the sawdust to prevent it from being drawn into the housing</p>
The machine does not cut at 45° or 90° angles.	<ol style="list-style-type: none"> <li>1. The table is not at right angles to the blade.</li> <li>2. The blade is dull or too much pressure was put on the workpiece.</li> </ol>	<p>Adjust the table. Replace the blade or put less pressure on the workpiece.</p>
The blade cannot be properly positioned on the band wheels.	<ol style="list-style-type: none"> <li>1. The wheels are not aligned.</li> <li>2. The blade tracking knob hasn't been properly adjusted.</li> <li>3. Inferior blade.</li> </ol>	<p>Contact Technical Support @ 877-884-5167 or techsupport@rikontools.com. Adjust the knob (see pages 14, 26 and 27). Replace the blade.</p>

For parts or technical questions contact: techsupport@rikontools.com or 877-884-5167.

## TROUBLESHOOTING

**⚠ WARNING** THE MACHINE MUST NOT BE PLUGGED IN AND THE POWER SWITCH MUST BE IN THE OFF POSITION UNTIL ALL ADJUSTMENTS ARE COMPLETE.

### CHANGING THE MOTOR DRIVE BELT

Before changing the belt, make sure that the bandsaw is unplugged from the power source. To change the drive belt:

1. Release the tension on the bandsaw blade and move the blade off of the lower wheel, or take the blade totally off from the saw. See page 16.
2. Remove the tension from the drive belt by turning the belt tensioning Handwheel (#26E). Take the old belt off of the wheel and pulleys.
3. Take the Lower Wheel (#13E) off of the saw. Remove the Allen Screw, Spring Washer and Flat Washer (#22, 23, 21E) in the middle of the lower wheel. Carefully pull the wheel off the shaft (#15E).
4. Install the new belt and reverse the process outlined above. Tension the drive belt until there is 3/8" to 1/2" of deflection. See page 21.

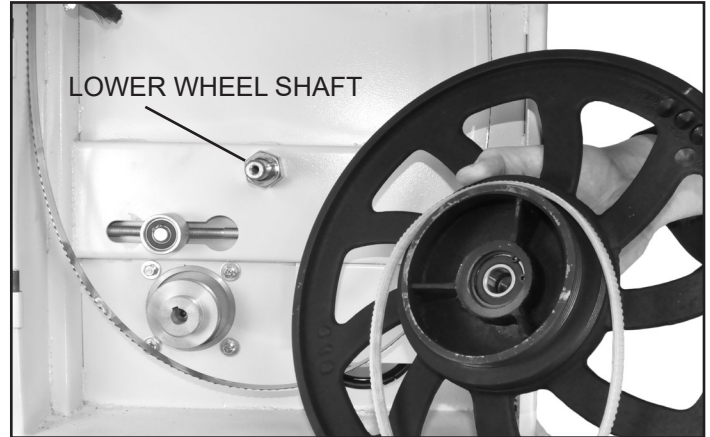

FIGURE 44



FIGURE 45

### LEVELING THE TABLE INSERT

The table insert has an innovative built in micro-adjustment feature. This adjustment can be used if the table insert sits too high or too low in the table seat. If the insert is resting above the table, turn the micro-screws with a hex "L" wrench counter clockwise to lower the insert. If the insert is sitting below the table, turn the micro-screws clockwise to raise the insert level with the table.

**Caution:** Having the insert below the top of the table could cause the workpiece to get stuck on the lip of the table seat, particularly on the back area of the table seat in back of the blade.

### CHANGING BANDSAW TIRES

Use a putty knife to get underneath the tire and pull it up and away from the wheel. Work the putty knife all the way around the wheel to loosen the tire. Then, use the putty knife as leverage to flip the tire over and off of the wheel. Clean the inside of the groove, removing any dirt, debris or cement with lacquer thinner.

Soak the replacement tire in warm water to make it more flexible. Dry the tire, and while it is still warm, lay it on top of the wheel. Start by setting the tire into the wheel groove at the top of the wheel. Using a putty knife, work the new tire around the wheel, making sure not to slice the tire. If rubber cement is to be used as a binder, make sure to distribute it evenly. Having high spots between the wheel and the tire will cause a vibration and effect blade tracking.

## TROUBLESHOOTING

### LOWER WHEEL ADJUSTMENTS

The following instructions will correct common blade issues related to the lower wheel's alignment in relation to the upper wheel. These adjustments will correct the blade position on the lower wheel and blade oscillation (wobble). These are critical adjustments which affect the performance and accuracy of the bandsaw.

**CAUTION** PLEASE READ AND UNDERSTAND THESE STEPS THOROUGHLY BEFORE MAKING ANY ADJUSTMENTS. FAILURE TO DO SO COULD DAMAGE THE MACHINE.

Please contact a tech support representative if you have questions before attempting these adjustments. RIKON Tech Support 877-884-5167 techsupport@rikontools.com

Release the blade tension completely before making any lower wheel adjustments. Pressure must be released on the lower wheel to allow proper adjustments and to avoid damaging the machine.

If the blade is not running true, or it is not running on center of the lower wheel but is correct on the upper wheel, then an adjustment to the wheel hub on the rear of the bandsaw is required.

The numbers shown on the rear hub photo represent the positions on a clock face.

**NOTE:** To help identify the extent of rotation on a bolt, mark a black dot on the edge of the bolt as a visual indicator.

*If a blade is tracking forward on the lower wheel toward the door, follow these correction steps:*

- 1.) De-tension the saw blade.
- 2.) Loosen 9 o'clock shaft bolt to take pressure off the shaft.
- 3.) Loosen 12 o'clock shaft bolt one half rotation.
- 4.) Tighten the 6 o'clock shaft bolt until the shaft touches the 12 o'clock adjusting bolt.
- 5.) Lock all three shaft bolts.
- 6.) Re-tension the saw blade and set the upper wheel to plumb by adjusting the tracking knob. Spin the upper wheel by hand and track the blade.
- 7.) Repeat if further adjustment is necessary.



CONTINUED ON PAGE 27

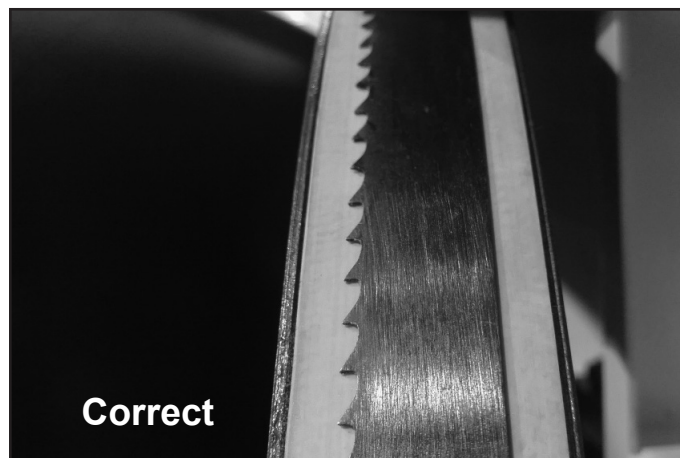
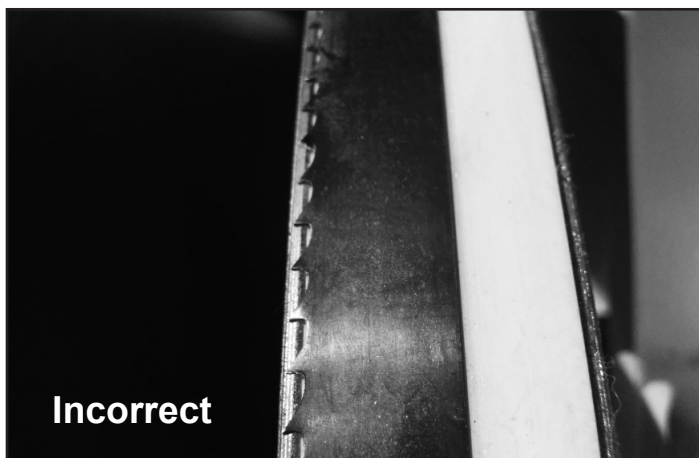

## TROUBLESHOOTING

If a blade is tracking on the rear of the lower wheel, away from the door, follow these steps:

- 1.) De-tension the saw blade.
- 2.) Loosen 9 o'clock shaft bolt to take pressure off the shaft.
- 3.) Loosen 6 o'clock shaft bolt one half rotation.
- 4.) Tighten the 12 o'clock shaft bolt until the shaft touches the 6 o'clock adjusting bolt.
- 5.) Lock all three shaft bolts.
- 6.) Re-tension the saw blade and set the upper wheel to plumb by adjusting the tracking knob. Spin the upper wheel by hand and track the blade.
- 7.) Repeat if further adjustment is necessary.

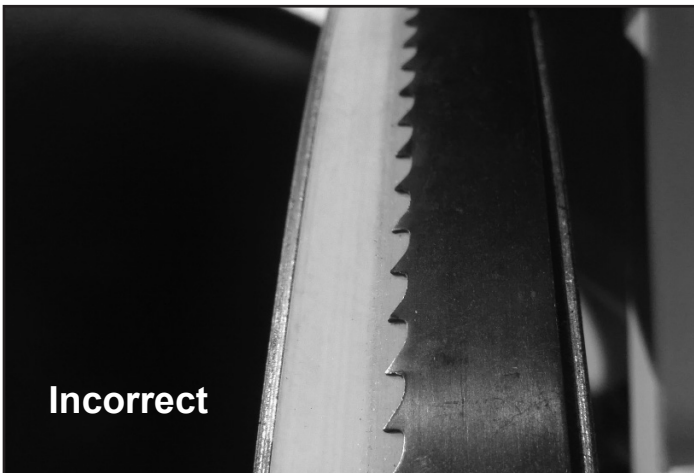

If a blade is moving back and forth (wobbling) follow these steps:

First, check the bandsaw blade to insure that it has been welded correctly, so that the blade's back is in proper alignment - flat (if it is laid down on a table surface).

If the blade is welded true, then adjustment to the wheel hub on the rear of the bandsaw is required.

- 1.) De-tension the saw blade.
- 2.) Loosen 6 o'clock shaft bolt to take pressure off of the shaft.
- 3.) Loosen 9 o'clock shaft bolt one half rotation.
- 4.) Tighten the 3 o'clock shaft bolt until the shaft touches the 9 o'clock adjusting bolt.
- 5.) Lock all three shaft bolts.
- 6.) Re-tension the saw blade and set the upper wheel to plumb by adjusting the tracking knob. Spin the upper wheel by hand and track the blade.
- 7.) Start the bandsaw and check blade movement.
- 8.) If movement has diminished then continue with the adjustment.
- 9.) If movement is worse, reverse the adjustments in steps 3 and 4.

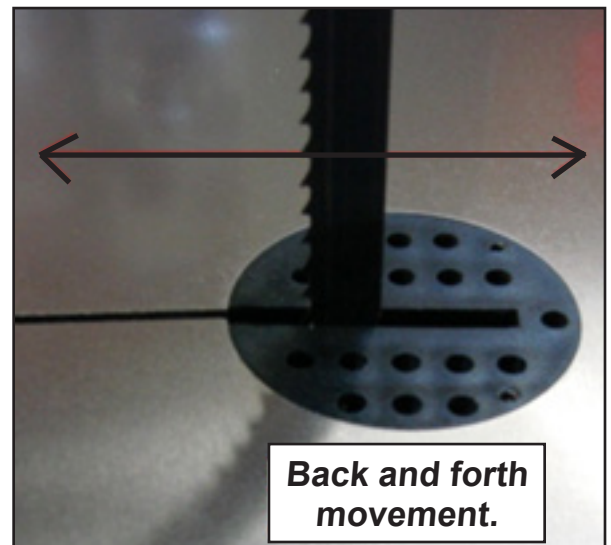



# PARTS DIAGRAM

## FRAME ASSEMBLY SHEET A

**NOTE:** Please reference the Manufacturer's Part Number when calling for Replacement Parts. For Parts under Warranty, the Serial Number of your machine is required.

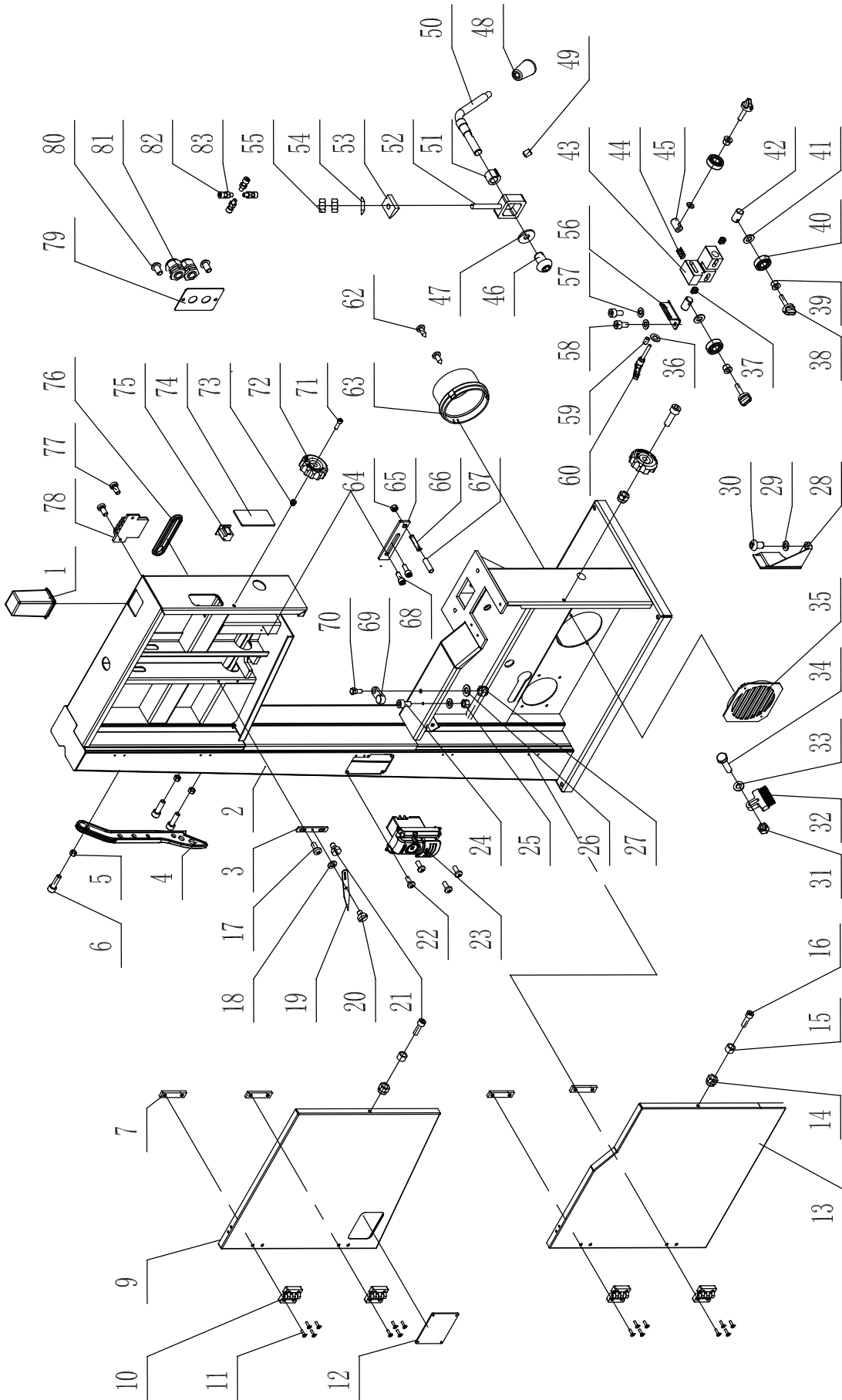

# PARTS LIST

## FRAME ASSEMBLY - SHEET A

KEY NO.	DESCRIPTION	PART NO.	QTY.	KEY NO.	DESCRIPTION	PART NO.	QTY.
1A	Guide post cap	1-JL28010003-001S	1	43A	Lower blade guide block	1-JMBS1401013001	1
2A	Frame	1-JMBS1401011000-117U	1	44A	Spring	1-JMBS1403014008	1
3A	Indicator adjustment plate	1-JL27010005	1	45A	Rear guide shaft	1-JMBS1403014004	1
4A	Push stick	1-JL81100003-146S	1	46A	Screw M8x12	1-M8X12GB70D2B	1
5A	Hex nut M6	1-M6GB6170B	3	47A	Big washer	1-WSH8GB96B	1
6A	Hex bolt M6x30	1-M6X30GB70D1B	3	48A	Quick release rod	1-1904011	1
7A	Threaded plate	1-JMBS1401010005	4	49A	Socket hd cap screw M8x8	1-M8X8GB80B	1
9A	Upper wheel cover	1-JMBS1404010200-076U	1	50A	Camshaft	1-JMBS1401012001	1
10A	Hinge	1-JMBS1404010400	4	51A	Cam	1-JMBS1403016004	1
11A	Hex socket screw M4x16	1-M4X16GB70D3B	16	52A	Slide bracket	1-JMBS1403016003	1
12A	Clear window	1-JL26010001	1	53A	Spacer	1-JMBS1403030004	1
13A	Lower bandwheel door	1-JMBS1401010003-076U	1	54A	Washer	1-WSH10GB849B	1
14A	Nylon nut M6-1.0	1-M6GB889Z	2	55A	Nut M10	1-M10GB6170B	2
15A	Bushing	1-JL26010007	2	56A	Connecting plate	1-JMBS1401010001-117U	1
16A	Carriage bolt M6x20	1-M6X20GB70D1Z	2	57A	Carriage bolt M5x12	1-M5X12GB70B	2
17A	Screw M5x10	1-M5X10GB818Z	1	58A	Washer	1-WSH5GB97D1B	2
18A	Washer	1-WSH5GB97D1Z	2	59A	Set screw M6x10	1-M6X10GB77B	1
19A	Pointer	1-JL27010004-114X	1	60A	Adjusting handle	1-KTSB-1-B-M6X50X10	1
20A	Special screw	1-JL26010010	1	62A	Tapping screw	1-ST3D5X9D5GB845B	2
21A	Fixed bolt	1-JL27010019	1	63A	Dust port	1-JL20010007-001S	1
22A	Pan head screw M4x10	1-M4X10GB823B	4	64A	Nut M6	1-M6GB6170Z	1
23A	On/Off switch	1-HY56-6	1	65A	Connecting plate	1-JMBS1401010004	1
24A	Screw M5x10	1-M5X10GB70Z	1	66A	Set screw M6x30	1-M6X30GB77B	1
25A	Nut M5	1-M5GB6170Z	1	67A	Plastic pipe	1-JXBS2401010018	1
26A	Washer	1-WSH8GB97D1B	1	68A	Nut M5x12	1-M5X12GB70Z	1
27A	Nylon nut M8	1-M8GB889B	1	69A	Table angle stop block	1-JL21010014	1
28A	Lower blade guard	1-JMBS1401010002-001S	1	70A	Stud shaft	1-JL26010015	1
29A	Washer	1-WSH6GB97D1B	1	71A	Carriage bolt M6x20	1-M6X20GB70D1Z	2
30A	Bolt M6x12	1-M6X12GB70D2B	1	72A	Star knob	1-JL26010006-001S	2
31A	Self-locking nut M6	1-M6GB889Z	1	73A	Nylon nut M6-1.0	1-M6GB889Z	2
32A	Brush	1-JL26010003	1	74A	Clear window	1-JMBS1404010001	1
33A	Washer	1-WSH6GB96Z	1	75A	Plug seat	1-DB-F-M	1
34A	Hex bolt M6x25	1-M6X25GB5783Z	1	76A	Rubber cover	1-JL28010005-001S	1
35A	Dust port grille	1-JL20010019-001S	1	77A	Pan head screw M5x10	1-M5X10GB818B	2
36A	Big washer	1-WSH6GB96B	1	78A	Tool holder	1-JL26090001	1
37A	Spring	1-JMBS1403014005	2	79A	Strain relief plate	1-JL26010011-117U	1
38A	Locking handle	1-JMBS1403014006-001S	3	80A	Hex socket screw M6x10	1-M6X10GB70D2B	2
39A	Upper bearing bushing	1-JMBS1403014002	3	81A	Strain relief M20	1-JL91046100	2
40A	Bearing	1-BRG6202-2RSGB276	3	82A	Hex socket screw M8x25	1-M8X25GB5783B	4
41A	Washer	1-WSH8GB96B	3	83A	Nut M8	1-M8GB6170B	4
42A	Guide shaft	1-JMBS1403014003	2				

# PARTS DIAGRAM

## TABLE ASSEMBLY SHEET B

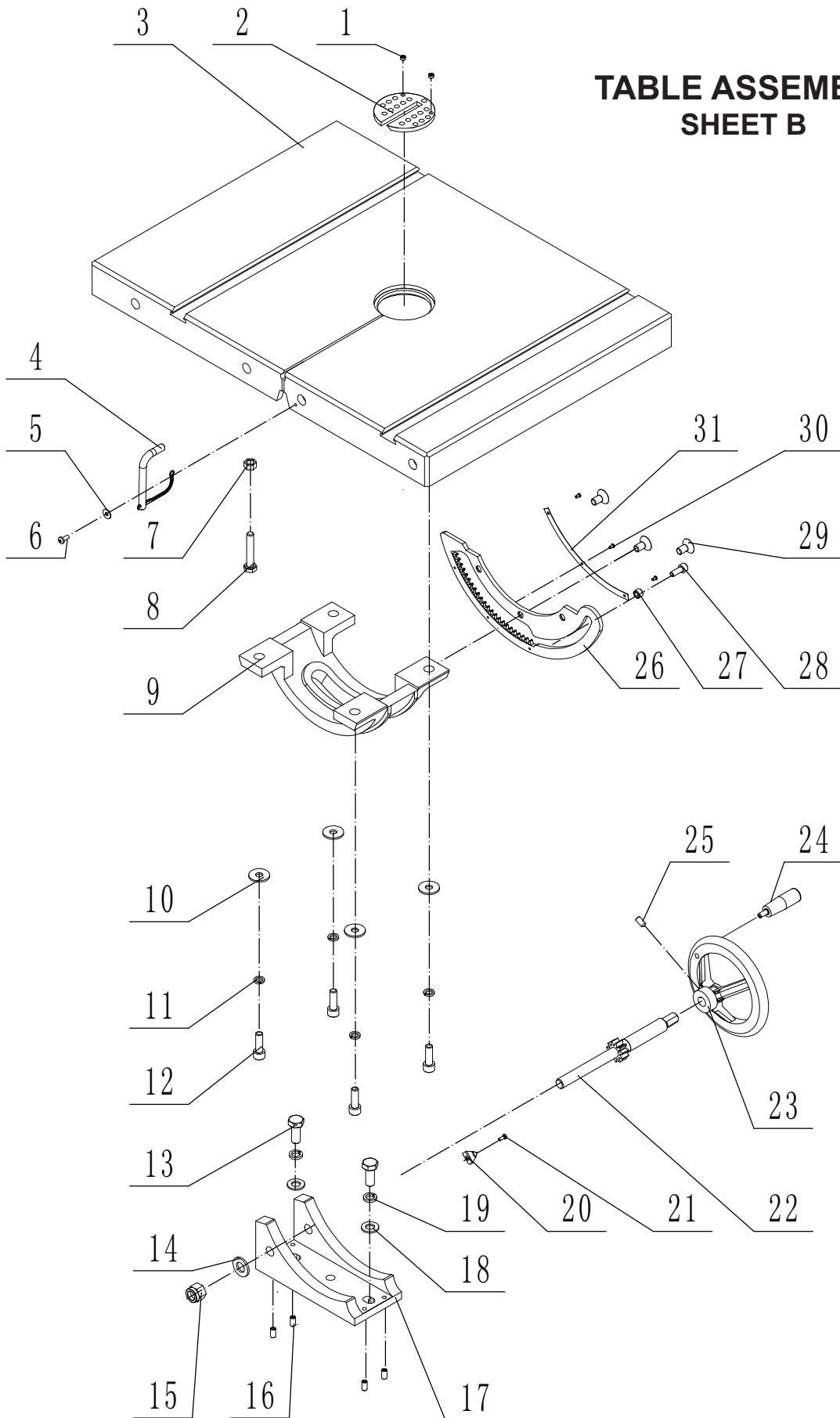

# PARTS LIST

## TABLE ASSEMBLY SHEET B

KEY NO.	DESCRIPTION	PART NO.	QTY.
1B	Set screw	1-M6X4GB77B	2
2B	Table insert	1-JL26050008A-001S	1
3B	Table	1-JMBS1401030001-001L	1
4B	Table alignment pin & lanyard	1-JMBS1404030002	1
5B	Washer	1-WSH4GB96Z	1
6B	Pan head screw M4x10	1-M4X10GB818Z	1
7B	Hex nut M8	1-M8GB6170Z	1
8B	Hex bolt M8x45	1-M8X45GB5783Z	1
9B	Table trunnion	1-JMBS1403030002	1
10B	Washer	1-WSH8GB96B	4
11B	Spring washer	1-WSH8GB93B	4
12B	Hex socket cap screw M8x25	1-M8X25GB70B	4
13B	Hex bolt M10x25	1-M10X25GB5783B	2
14B	Flat washer M12	1-WSH12GB97D1B	1
15B	Hex self-locking nut M12	1-M12GB889B	1
16B	Set screw M6x12	1-M6X12GB77B	4
17B	Trunnion support	1-JMBS1403030005	1
18B	Flat washer M10	1-WSH10GB97D1B	2
19B	Spring washer	1-WSH10GB93B	2
20B	Pointer	1-JXBS2401031008A	1
21B	Cross recess pan head screw M3x8	1-M3X8GB818Z	1
22B	Gear shaft	1-JMBS1403030007	1
23B	Crank handwheel	1-SGSL-D125-d12	1
24B	Small handle	1-JL26020014-001S	1
25B	Lock screw M6x12	1-M6X12GB80B	1
26B	Rack	1-JMBS1403030003	1
27B	Eccentric bushing	1-JMBS1403030008	1
28B	Screw M6x16	1-M6X16GB70B	1
29B	Hex countersunk head screw M8x16	1-M8X16GB70D3Z	3
30B	Rivet 2D5x5	1-RVT2D5X5GB827C	3
31B	Angle scale label	1-JMBS1403030006	1

**NOTE:** Please reference the Manufacturer's Part Number when calling for Replacement Parts.  
For Parts under Warranty, the Serial Number of your machine is required.



# PARTS DIAGRAM

## BLADE GUARD & TOP GUIDE ASSEMBLY SHEET C

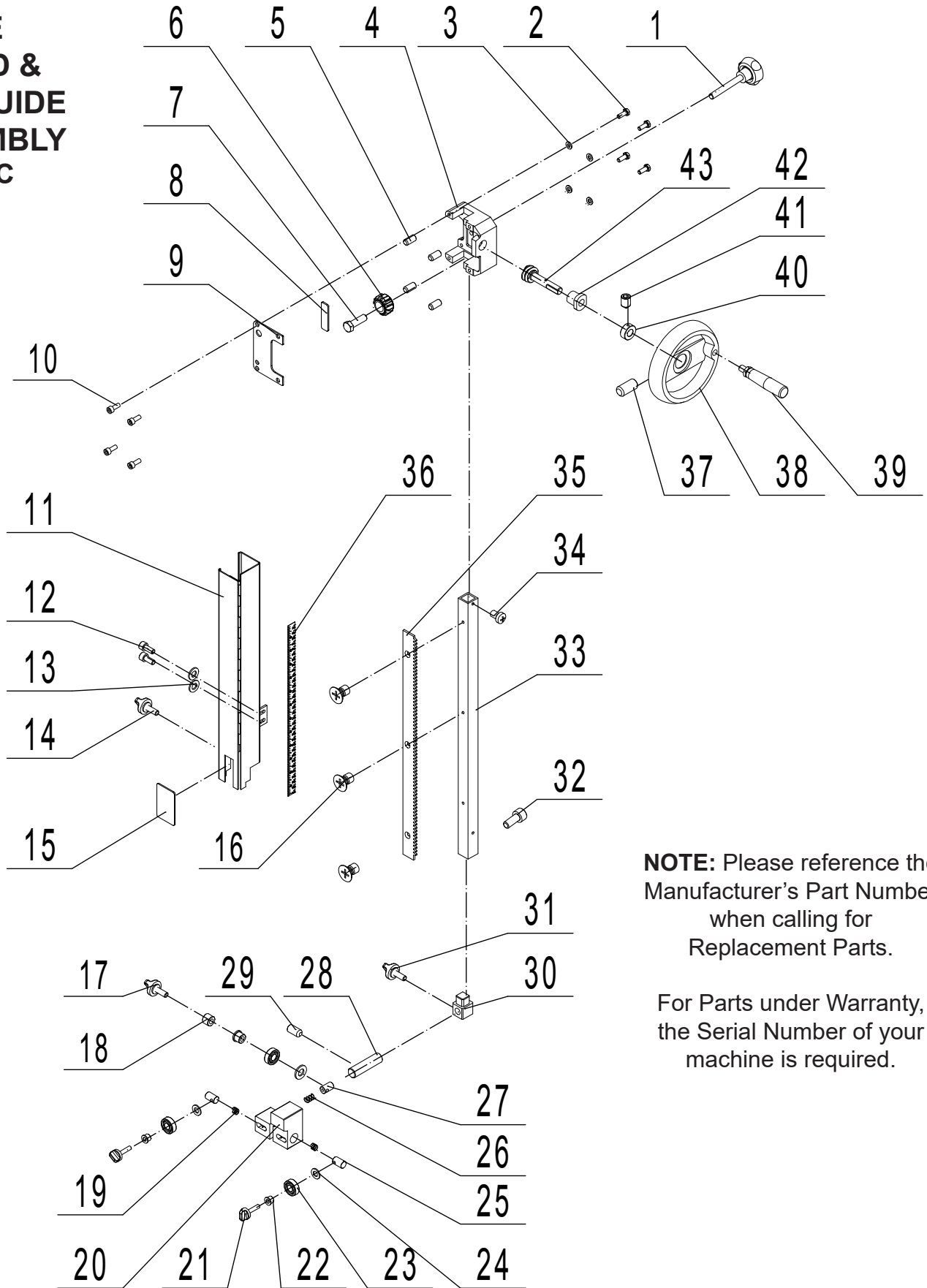

**NOTE:** Please reference the Manufacturer's Part Number when calling for Replacement Parts.

For Parts under Warranty, the Serial Number of your machine is required.

# PARTS LIST

## BLADE GUARD & TOP GUIDE ASSEMBLY - SHEET C

KEY NO.	DESCRIPTION	PART NO.	QTY.
1C	Locking handle	1-JL82240011-001S	1
2C	Hex bolt M6x16	1-M6X16GB5783B	4
3C	Washer	1-WSH6GB96B	4
4C	Guide bracket	1-JL27040006	1
5C	Set screw	1-M6X12GB77B	4
6C	Gear	1-1501006	1
7C	Fixed bolt	1-JL26040006	1
8C	Fixed plate	1-JL26040007	1
9C	Guide bracket cover	1-JL27040002A	1
10C	Hex socket screw M6x16	1-M6X16GB70Z	4
11C	Hinged door	1-JMBS1401052000-114X	1
12C	Carriage bolt M5x12	1-M5X12GB70B	2
13C	Washer	1-WSH5GB97D1B	2
14C	Locking handle	1-JMBS1403050004-001S	1
15C	Clear window	1-JMBS1404050001	1
16C	Hex socket screw M5x8	1-M5X8GB819B	3
17C	Long clamp handle	1-JMBS1801052002	1
18C	Fixed block	1-JMBS1403014007	1
19C	Spring	1-JMBS1403014005	2
20C	Upper guide	1-JMBS1401051001	1
21C	Lock handle	1-JMBS1403014006-001S	2
22C	Bushing	1-JMBS1403014002	3
23C	Bearing	1-BRG6202-2RSGB276	3
24C	Washer	1-WSH8GB96B	3
25C	Guide shaft	1-JMBS1403014003	2
26C	Spring	1-JMBS1403014008	1
27C	Rear guide shaft	1-JMBS1403014004	1
28C	Guide	1-JMBS1401051002	1
29C	Hex socket end lock screw M6X12	1-M6X12GB80B	1
30C	Upper guide support block	1-JMBS1401050001	1
31C	Lock ratchet handle	1-KTSB-1-B-M8X63X20	1
32C	Screw M5X25	1-M5X25GB70D1B	1
33C	Guide post	1-JMBS1401050002	1
34C	Pan head screw M5X8	1-M5X8GB818B	1
35C	Gear rack	1-1-JL28040001A	1
36C	Scale	1-JMBS1401050003	1
37C	Hex socket end lock screw M6X12	1-M6X12GB77B	1
38C	Crank handwheel	1-SGSL-D100-d10	1
39C	Handwheel handle	1-JL26020014B-001S	1
40C	Set collar	1-JL20010015	1
41C	Set screw	1-M5X8GB71B	1
42C	Bushing	1-JL27040003	1
43C	Worm cylinder	1-JL27040004	1

# PARTS DIAGRAM

## BLADE TENSION & TRACKING ASSEMBLY SHEET D

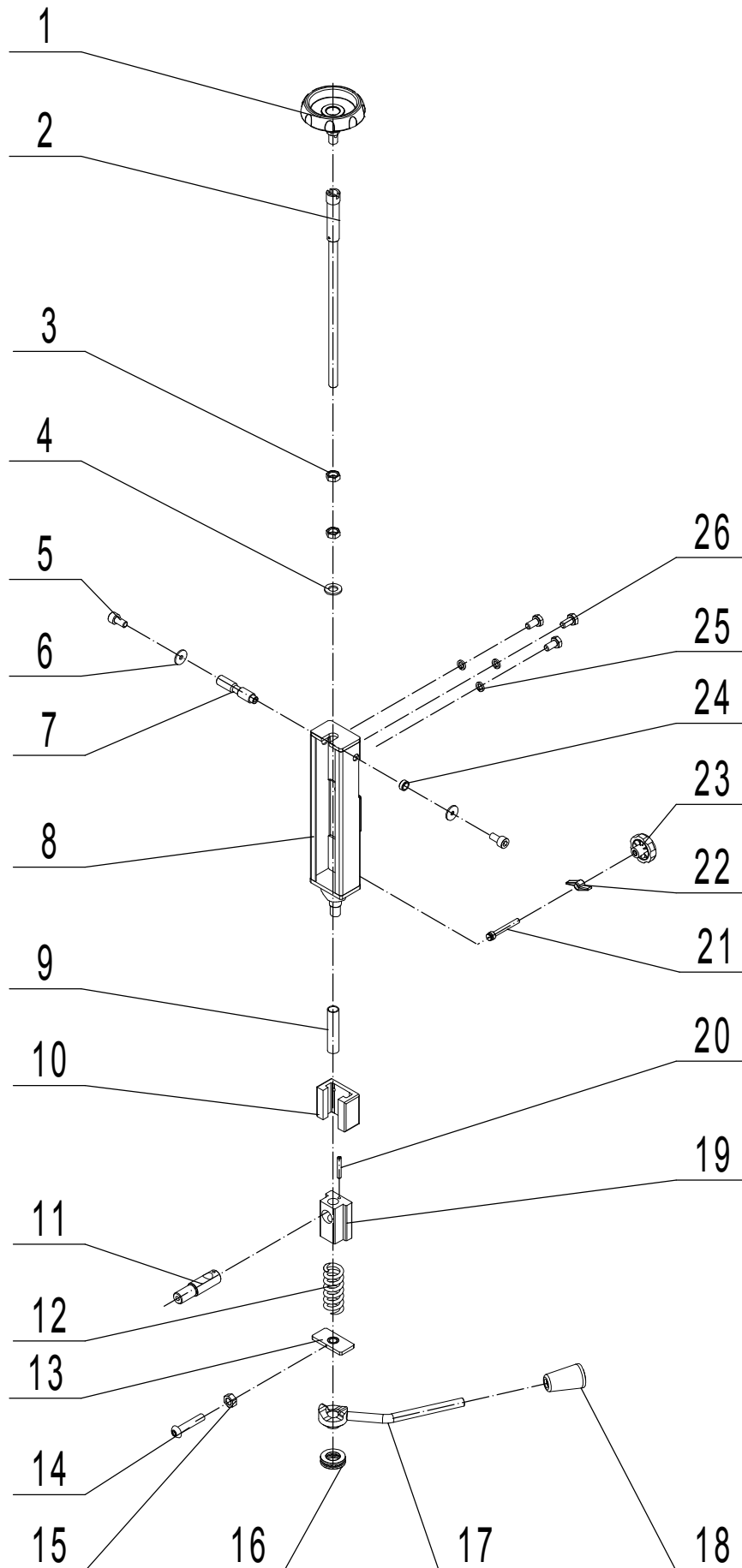

# PARTS LIST

## BLADE TENSION & TRACKING ASSEMBLY - SHEET D

KEY NO.	DESCRIPTION	PART NO.	QTY.
1D	Blade tension handwheel	1-JL21025000A001S	1
2D	Blade tension rod	1-JL28032000A	1
3D	Special hex nut	1-JL28030003	2
4D	Washer	1-WSH12GB97D1Z	1
5D	Hex socket screw M6x12	1-M6X12GB70D1Z	2
6D	Washer	1-WSH6GB5287Z	2
7D	Upper shaft	1-JL28030008	1
8D	Slide bracket	1-JL28031000	1
9D	Tube	1-JL28030001	1
10D	Sliding rail	1-JL28030010	1
11D	Upper wheel shaft	1-JL28030004	1
12D	Spring	1-JL27030011A	1
13D	Block	1-JMBS1404040001	1
14D	Hex socket screw M3x16	1-M3X16GB70D2B	1
15D	Hex nut M3	1-M3GB6170B	1
16D	Thrust bearing	1-BRG51104GB301	1
17D	Quick release handle	1-JL28033000	1
18D	Quick release knob	1-1904011	1
19D	Upper wheel shaft hinge	1-JL28030007	1
20D	Pin roll 5x35	1-PIN5X35GB879D1B	1
21D	Quick stop bolt	1-JL28030005	1
22D	Wing nut	1-JL20010016A-001S	1
23D	Blade tracking handle	1-JL26040015A-001S	1
24D	Washer	1-JL28030009	1
25D	Spring washer	1-WSH6GB93B	3
26D	Hex bolt M6X12	1-M6X12GB5781B	3

**NOTE:** Please reference the Manufacturer's Part Number when calling for Replacement Parts.  
For Parts under Warranty, the Serial Number of your machine is required.



# PARTS DIAGRAM

## MOTOR & WHEEL ASSEMBLY SHEET E

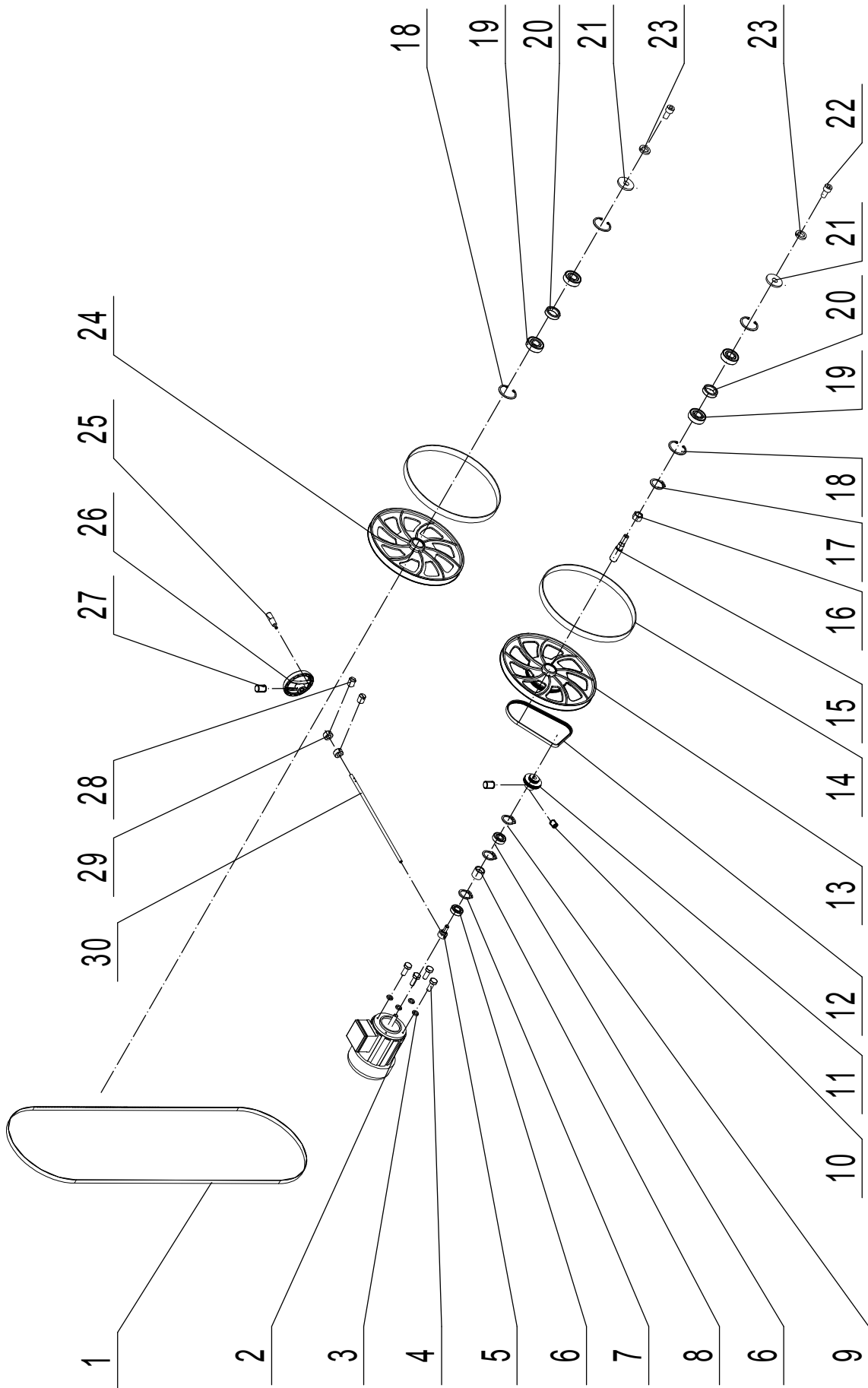

# PARTS LIST

KEY NO.	DESCRIPTION	PART NO.	QTY.
1E	Blade	1-JL28020001C	1
2E	Motor	2-YLH906134	1
3E	Spring Washer	1-WSH6GB93Z	4
4E	Hex. Bolt M6x16	1-M6X16GB5783Z	4
5E	Sliding shaft	1-JL20014001	1
6E	Bearing	1-BRG6001-2RSGB276	2
7E	Retainer ring	1-CLP28GB893D1B	2
8E	Tension wheel	1-JL20014002A	1
9E	Retaining spring	1-CLP12GB894D1B	1
10E	Hex socket screw M6x8	1-M6X8GB80B	2
11E	Motor pulley	1-JL20070001	1
12E	Multi-vee belt	1-JL20020002	1
13E	Lower bandwheel	1-JL28023001-001L	1
14E	Tire	1-JL21022002B	2
15E	Lower bandwheel shaft	1-JL28020002A	1
16E	Nut	1-JL20020004	1
17E	Retaining ring 17	1-CLP17GB894D1B	1
18E	Retaining ring 40	1-CLP40GB893D1B	4
19E	Bearing	1-BRG6203-2RSGB276	4
20E	Tube	1-JL28020004	2
21E	Washer	1-WSH8GB5287Z	2
22E	Hex screw M8x16	1-M8X16GB70Z	2
23E	Spring washer	1-WSH8GB93Z	2
24E	Upper bandwheel	1-JL28022001-001L	1
25E	Handwheel handle	1-JL26020014B-001S	1
26E	Crank handwheel	1-SGSL-D100-d10	1
27E	Set screw M6x8	1-M6X8GB77B	1
28E	Set screw M5x8	1-M5X8GB71Z	2
29E	Set collar	1-CLP10GB884Z	2
30E	Crank	1-JL28020003A	1

**NOTE:** Please reference the Manufacturer's Part Number when calling for Replacement Parts.

For Parts under Warranty, the Serial Number of your machine is required.

# PARTS DIAGRAM

## FENCE ASSEMBLY SHEET F

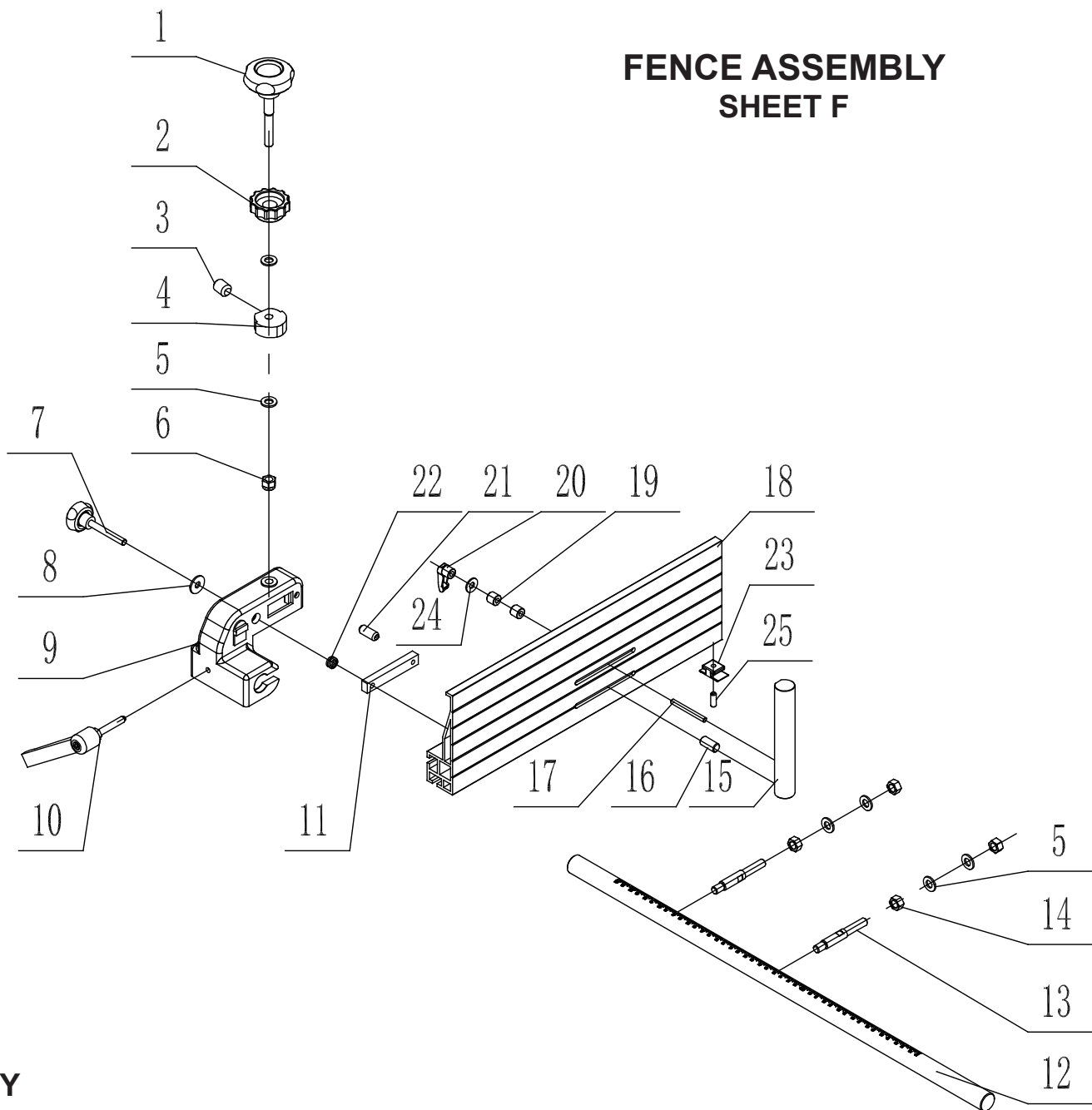

### KEY

NO.	DESCRIPTION	PART NO.	QTY.
1F	Adjusting handle	1-JMBS1403060009-001S	1
2F	Locking knob	1-JMBS1403060010-001S	1
3F	Cap screw M8X10	1-M8X10GB80B	1
4F	Cam	1-JMBS1403060004	1
5F	Flat washer	1-WSH10GB97D1Z	6
6F	Nut M10	1-M10GB889Z	1
7F	Handle	1-JMBS1403060003-001S	1
8F	Big washer	1-WSH8GB96Z	1
9F	Rip fence carrier	1-JMBS1403060001-076U	1
10F	Locking handle	1-JMBS1403060011	1
11F	Sliding block	1-JMBS1403060005	1
12F	Front guide rail	1-JMBS1403060006	1
13F	Connecting rod	1-JXBS2001060003	2
14F	Hex nut M10	1-M10GB6170Z	4

### KEY

NO.	DESCRIPTION	PART NO.	QTY.
15F	Re-saw bar	1-JMBS1403061001	1
16F	Screw	1-JL26061003	1
17F	Bolt	1-JMBS1403061002	1
18F	Rip fence	1-JMBS1403060002	1
19F	Tube	1-JL93010018	2
20F	Locking handle	1-KT5B-1-A-M6X50	1
21F	Roll pin	1-PIN6X26GB879B	1
22F	Spring	1-JMBS1403060007	1
23F	Nylon plate	1-JMBS1401060001	1
24F	Washer	1-WSH6GB97D1B	1
25F	Set screw	1-M6X16GB77B	1

# PARTS LIST

## CABINET ASSEMBLY SHEET G

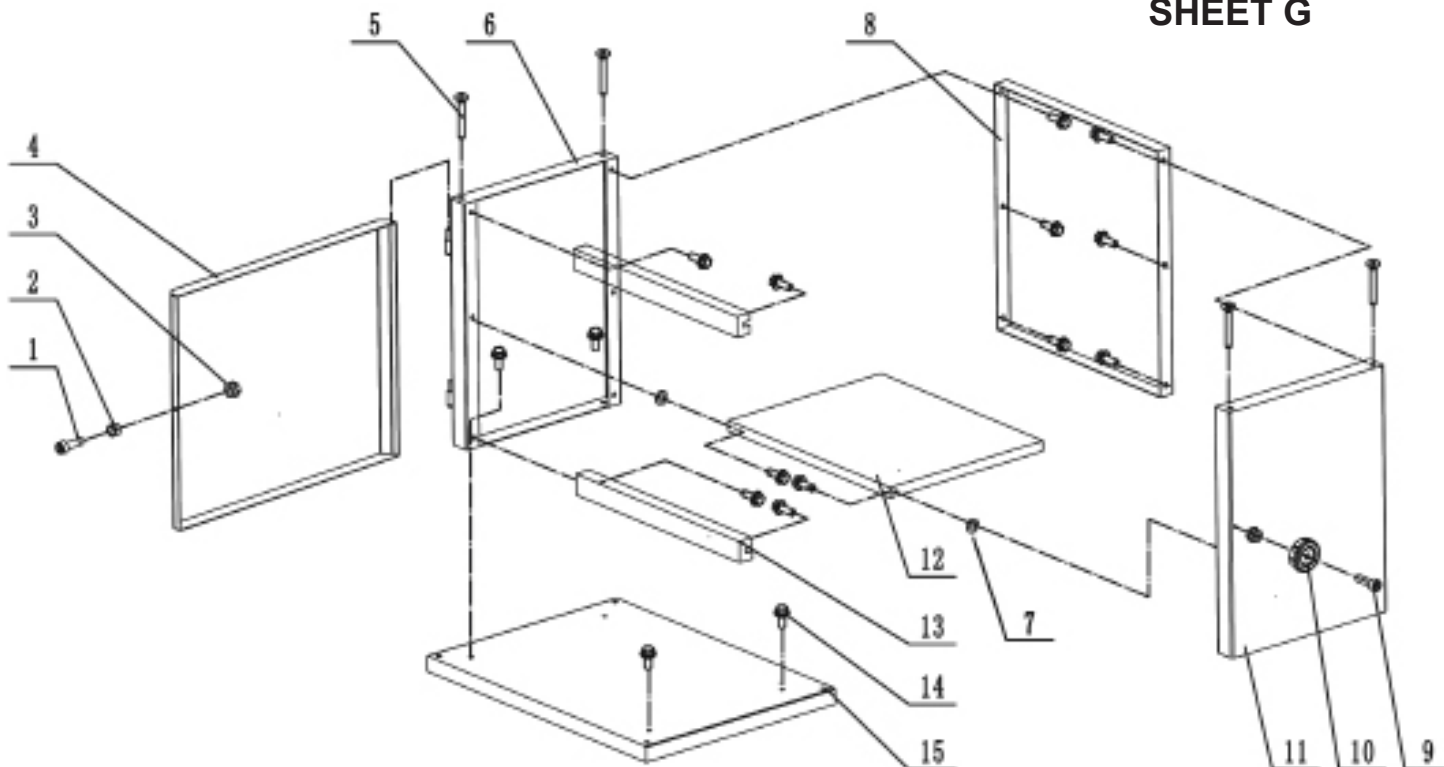

KEY NO.	DESCRIPTION	QTY.	PART NO.
1G	Screw M6X16	1	1-M6X16GB70Z
2G	Bushing	1	1-JL20010001A
3G	Self-locking nut M6	2	1-M6GB889Z
4G	Door assembly	1	1-JL28051000-076U
5G	Countersunk hex socket screw M6X50	4	1-M6X50GB70D3Z
6G	Left side panel	1	1-JL28050002A-076U
7G	Big washer	2	1-WSH8GB96Z
8G	Back side panel	1	1-JL28050001A-076U
9G	Hex socket cap screw M6X20	1	1-M6X20GB70D1Z
10G	Handle	1	1-JL26010006-001S
11G	Right side panel	1	1-JL28050006A-076U
12G	Shelf	1	1-JL28050004-076U
13G	Beam	2	1-JL28050003A-076U
14G	Hex bolt with flange M8X20	16	1-M8X20GB5789Z
15G	Base board	1	1-JL28050005B-076U

**NOTE:** Please reference the Manufacturer's Part Number when calling for Replacement Parts. For Parts under Warranty, the Serial Number of your machine is required.



## How-To's for all Band Saw Blades

### Choosing the Correct Blade Width

Blade width is measured from the tips of the teeth to the back edge of the blade as shown above. The instructions for the particular machine being used should be followed when selecting blade width.



If no such instructions are provided, blade width should be determined with the following guidelines:

For Cut-Off Sawing, the blade should be as wide as the machine will allow. The wider the band is, the straighter the cut will be. Faster feeding can be achieved.

For Contour Sawing, the blade should be as wide as the machine allows, but still narrow enough so that it can cut the desired shape (radius). Minimum dimensions for different cutting radii are shown on the chart at right.

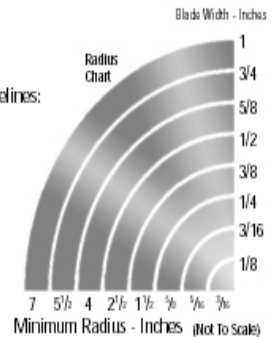

### How To Choose The Correct Number Of Teeth Per Inch (TPI)

The number of teeth per inch (TPI) is important in obtaining the finish desired and the proper feed rate. A coarse tooth blade (2, 3 TPI) should be used for resawing wood and cutting thicker stock up to 8". A fine toothed blade (18 to 32 TPI) should be used for thinner metals and plastics under 1/4". For general cutting of 3/4" wood 4 TPI will provide a fast cut and 14 TPI will cut slow, but leave a smoother finish.

When Selecting TPI remember:

- More TPI give a smoother but slower cut
- Fewer TPI allow a faster cut with a slightly rougher finish
- At least three teeth must be in the workpiece—the chart to the right will help you decide.

TPI	Minimum Material Thickness
32	3/32"
24	1/8"
18	5/32"
14	1/4"
10	5/16"
8	3/8"
6	1/2"
4	3/4"
3	1"
2	1-1/2"

It is important to know the SFM for the various speed settings of your band saw, so that you can select the proper speed for cutting wood or other materials. Check the operator's manual of your band saw to determine the SFM or use the following procedure:

1. Determine the RPM: check the operator's manual or clock the revolutions per minute of the wheels with a tachometer or revolution counter.
2. Measure the diameter of the drive wheel in inches and multiply by .262 to obtain the wheel circumference. The RPM times circumference equals the surface speed of the blade.  
 $RPM \times \text{diameter in inches} \times .262 = SFM.$

**Note:** Spring Steel Wood Cutting Band Saw Blades should never be operated at surface speeds above 3000 SFM. Carbon Hard Edge Flexible Back Band Saw Blades may be run up to 8000 SFM.

### Installing your Band Saw Blade

1. Unplug the saw, then loosen the tension on the upper wheel. With all the blade guides backed off, slip the new blade around the wheels and then tension it.
2. When you have tensioned the blade enough to keep it on the wheels, track it by turning the upper wheel with one hand while adjusting the tilt of the wheel's axis with the other hand. The blade should ride in the middle of the rim. **Never track the blade with the motor running and the cover open.**
3. Next, adjust the blade guides; first the thrust bearings: upper and lower, then the left and side guides.
4. Use a square to make sure you are not pushing the blade out of line and place a piece of white paper between the blade guide and the blade to allow for clearance.

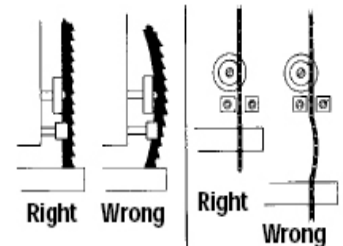

### Diagnosing Problems

#### 1. Premature and Excessive Tooth Wear

- Feed pressure too light, increase it.
- Lower band velocity.
- Improper tooth selection, use a finer pitch.
- Improper break-in with new band. Velocity and feeding should be reduced the first few cuts.
- Teeth are running the wrong direction.
- Teeth are pointing in proper direction.
- Incorrect saw guide insert size for the band, allowing them to strike teeth

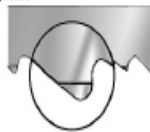

#### 2. Blade Vibration

- Increase or decrease band velocity.
- Teeth too coarse for workpiece.
- Material not securely held.
- Increase tension of band.
- Increase feed pressure.

#### 3. Gullets Loading

- Teeth too fine for workpiece - use a coarser pitch.
- Decrease band velocity.

#### 4. Band Stalls in Work

- Feed pressure too great - decrease feed.
- Teeth too coarse, use finer tooth blade

#### 5. Premature Blade Breakage

- Thickness of blade too heavy for diameter of wheels and speed of machine
- Increase or decrease velocity
- Check wheels for defects
- Teeth too coarse for workpiece - use a finer pitch
- Decrease blade tension - decrease feeding force
- Brittle weld - increase annealing period, decreasing heat gradually
- Check for proper adjustment of band guides, saw guides, saw guide inserts, and back-up bearings.

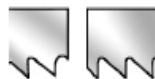

#### 6. Blade Making Belly-Shaped Cuts

- Increase tension.
- Adjust guides closer to workpiece.
- Teeth too fine - use a coarse pitch.
- Decrease feed force.
- Teeth dull.



#### 7. Tooth Stripping

- Teeth too coarse for workpiece.
- Material not securely held.
- Too much feed pressure - reduce for good chip curl.
- Band velocity too low - increase speed.

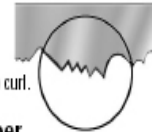

#### 8. Band Develops a Negative Camber

- Band is riding on saw guide backup bearing too heavily. Adjust band for alignment on top and bottom wheels.
- Check band wheel alignment.



#### 9. Blade Not Running True Against Saw Guide Backup Bearing

- If clicking noise against saw guide backup bearing, remove burr on band.
- Check band wheel alignment.
- Check saw guide backup bearing for wear, replace if necessary
- Weld not in proper alignment. Reweld blade straight and true.

#### 10. Cutting Rate Too Slow

- Increase band velocity.
- Increase feed pressure.
- Use a coarser pitch.

#### 11. Blade Leading In Cut

- Reduce feed pressure or rate.
- Check adjustments and wear of saw guides or rollers.
- Lack of band tension
- Tooth set damage.



#### 12. Premature Loss of Set

- Improper width selection - check chart for correct width for radius cutting.
- Reduce band velocity.

#### 13. Band Develops Positive Camber

- Decrease force.
- Use a coarser pitch to increase tooth penetration.
- Adjust saw guides closer to work.



#### 14. Band Develops Twist

- Wrong width for radius being cut - choose a narrower blade.
- Binding in cut - decrease feed pressure.
- Decrease band tension.
- Adjust saw guides further from workpiece.



#### 15. Finished Cut Surface Too Rough

- Improper tooth selection - choose a finer pitch.
- Increase band velocity.
- Decrease feed rate.



#### 16. Band Scoring (side wear or grooving)

- Check for wear on saw guide inserts.
- Too much pressure on saw guide inserts.
- Check alignment of saw guides - be sure they are square to front vise. Replace or clean guides.



#### 17. Burring or Mushrooming of Blade Back Edge

- Increase tension and adjust guides.
- Check contact between blade and back edge rollers.
- Reduce feed pressure.
- Use coarser pitch blade.
- Use finishing stone.



## WARRANTY

# RIKON

## POWER TOOLS

### 5-Year Limited Warranty

RIKON Power Tools Inc. ("Seller") warrants to only the original retail consumer/purchaser of our products that each product be free from defects in materials and workmanship for a period of five (5) years from the date the product was purchased at retail. This warranty may not be transferred.

This warranty does not apply to defects due directly or indirectly to misuse, abuse, negligence, accidents, repairs, alterations, lack of maintenance or normal wear and tear. Under no circumstances will Seller be liable for incidental or consequential damages resulting from defective products. All other warranties, expressed or implied, whether of merchantability, fitness for purpose, or otherwise are expressly disclaimed by Seller. This warranty does not cover products used for commercial, industrial or educational purposes.

This limited warranty does not apply to accessory items such as blades, drill bits, sanding discs, grinding wheels, belts, ball bearings and other related items.

Seller shall in no event be liable for death, injuries to persons or property, or for incidental, contingent, special, or consequential damages arising from the use of our products.

To take advantage of this warranty, proof of purchase documentation must be provided which has the date of purchase and an explanation of the complaint.

The Seller reserves the right to effect at any time, without prior notice, those alterations to parts, fittings, and accessory equipment which they may deem necessary for any reason whatsoever.

To take advantage of this warranty, please fill out the enclosed warranty card and send it to:

RIKON Warranty  
16 Progress Rd.  
Billerica, MA 01821

The card must be entirely completed in order for it to be valid. If you have any questions please contact us at 877-884-5167 or [warranty@rikontools.com](mailto:warranty@rikontools.com).

## ACCESSORIES

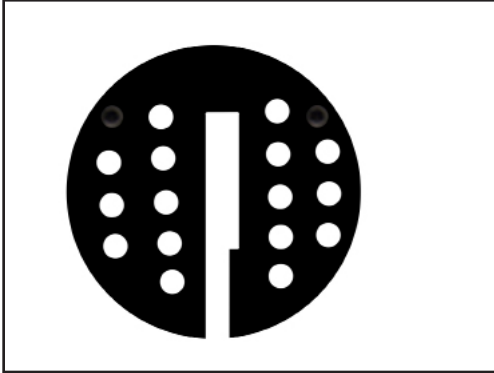

**C10-391 TABLE INSERTS - PK 4**  
Replacement plastic inserts with rear threaded holes for hex screw level-

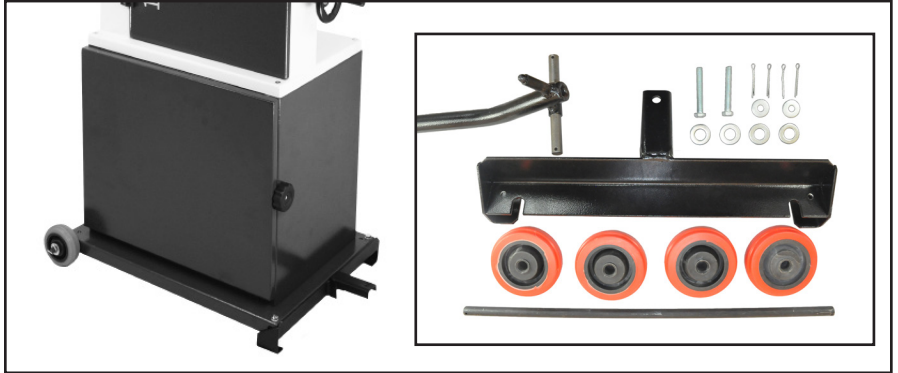

**13-325 MOBILITY KIT** Conversion Kit installs onto the bandsaw base to make it easy to move around the shop. Includes rear wheel assembly, front support, tow bar, hardware and instructions.

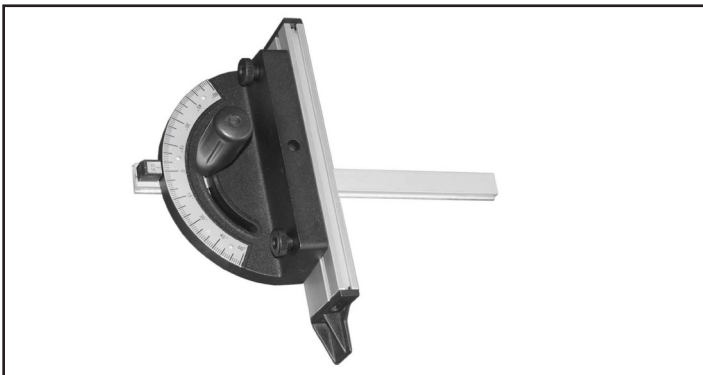

**13-912 'T' SLOT MITER GAUGE**  
Fits 3/4" x 3/8" miter slots. Handy scale for up to 60° left and right angle settings, includes adjustable 9" aluminium fence extension and push handle.

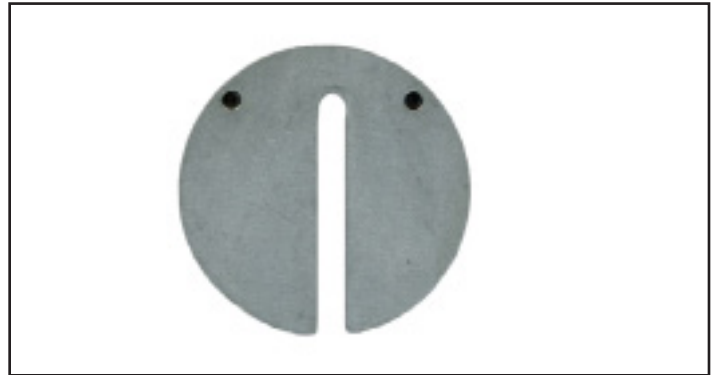

**C10-395 ALUMINIUM TABLE INSERT**  
Replacement cast aluminium insert with central slot for positioning the bandsaw blade. Provides solid support and includes rear table levelling screws.



**C10-392 ZERO CLEARANCE INSERTS - PK 4**  
Pack of four plastic inserts with table levelling screws. Inserts have no slot and require user to cut their own on installation. This minimizes the slot width so debris or thin cut wood strips will not catch or fall into the thin slot. Ideal for use when cutting small pieces on the bandsaw for inlay, shims, puzzles, etc.



**BAND SAW BLADES**  
For a complete line of 111" band saw blades, contact your local RIKON Distributor, or visit the RIKON website at [www.rikontools.com](http://www.rikontools.com).



LINK TO RIKON WEBSITE







**For more information:  
16 Progress Road  
Billerica, MA 01821**

**877-884-5167 / 978-528-5380  
techsupport@rikontools.com**

