



CT118

3-HP DUST COLLECTOR

OWNER'S MANUAL



COPYRIGHT © 2010 BY CRAFTEX INDUSTRIES INC.

NO PORTION OF THIS MANUAL MAY BE PRODUCED WITHOUT THE WRITTEN CONSENT OF CRAFTEX INDUSTRIES INC.



INDEX

GENERAL SAFETY INSTRUCTIONS	PAGE 3
SPECIFIC SAFETY INSTRUCTIONS	PAGE 4
Features	Page 5
Illustrated Features	Page 6
Unpacking	Page 7
Assembly	
Base Plate Assembly	Page 8
Motor/Impeller Assembly	Page 8
Collector Assembly	Page 9
Installing Collectors	Page 10
Collector Supports	Page 11
Filter & Collector Bags	Page 13
Filter & Collector Bags Cont'd	Page 14
Triple Gate Assembly	Page 15
Completed Dust Collector	Page 15
Grounding	Page 16
Useful Notes & Formulas	Page 17
Schematic Drawing	Page 18
Parts List	Page 19
Accessories	Page 20
Warranty	Page 21



GENERAL SAFETY INSTRUCTIONS

EXTREME CAUTION SHOULD BE USED IN OPERATING ALL POWER TOOLS. KNOW YOUR POWER TOOL, BE FAMILIAR WITH ITS OPERATION. READ THE OWNER'S MANUAL AND PRACTICE SAFE USAGE PROCEDURES AT ALL TIMES.

- ❑ **CONNECT** your machine **ONLY** to the matched and specified power source.
- ❑ **WEAR SAFETY GLASSES, RESPIRATORS, HEARING PROTECTION and SAFETY SHOES** when operating this machine.
- ❑ **DO NOT** wear loose clothing or jewellery when operating machinery.
- ❑ **A Safe Environment is important.** Keep the area free of dust, dirt and other debris in the immediate vicinity of the machine.
- ❑ **BE ALERT!** Do Not Use prescription or other drugs that may affect your ability or judgement to safely use this machine.
- ❑ **DISCONNECT** the power source when changing drill bits, hollow chisels, router bits, shaper heads, blades, knives or making other adjustments or repairs.
- ❑ **NEVER** leave an operating tool unattended.
- ❑ **NEVER** reach over the table when the tool is in operation.
- ❑ **NEVER** make crosscuts with the rip fence in place.
- ❑ **NEVER** attempt cut material that is warped or twisted.
- ❑ **ALWAYS** keep blades, knives or bits sharp and properly aligned.
- ❑ **ALWAYS** keep all safety guards in place and ensure their proper function.
- ❑ **ALWAYS** use push sticks and featherboards to safely feed your work through the machine.
- ❑ **ALWAYS** make sure that any tools used for adjustments are removed before operating the machine.
- ❑ **ALWAYS** secure your work with the appropriate clamps or vises.
- ❑ **ALWAYS** keep bystanders safely away while operating machinery.
- ❑ **THINK SAFETY. WORK SAFELY.** Never attempt a procedure if it does not feel safe or comfortable.

CT118 DUST COLLECTOR SPECIFIC SAFETY INSTRUCTIONS

- ❑ The CT118 is designed to collect sawdust ONLY.
- ❑ Never attempt to use this Dust Collector to vacuum water or any other liquids.
- ❑ Never try to use this Dust Collector to collect large wood pieces.
- ❑ Never attempt to use this Dust Collector to collect metal materials such as screws, nails or other metal parts.
- ❑ Never remove the filter bag or the collection bag with the motor operating.
- ❑ Never operate the Dust Collector with all blast gates closed.
- ❑ Always disconnect the CT118 from its power source when changing or emptying the bags.
- ❑ Always be sure that the collection and filter bags are securely fastened to the Collector Body.

CT118 DUST COLLECTOR FEATURES

As part of the growing line of **Craftex** woodworking equipment, we are proud to offer the CT118 Professional Dust Collection System. The **Craftex** name guarantees Craft Excellence. By following the instructions and procedures laid out in this owner's manual, you will receive years of excellent service and satisfaction. The CT118 is a professional tool and like all power tools, proper care and safety procedures should be adhered to.

This powerful low-noise factor dust collector is portable or may be set up in semi permanent locations. Transparency of the lower bag (made of polyethylene) allows you to view the contents without constantly opening the bag.

- ❑ Motor – 3 HP, single phase, 220 volt,
- ❑ Safety Power Switch with removable key.
- ❑ Balanced steel impeller.
- ❑ Impeller size – 12”.
- ❑ Upper Bag Filters Air to 1 Micron.
- ❑ Transparent Polyethylene lower collector bag for content visibility.
- ❑ Air Suction Capacity – 1,900 CFM
- ❑ Intakes – 3 @ 3” or 4”.
- ❑ Footprint – 35” x 50”.
- ❑ Mobile base for ease of movement.
- ❑ May be installed without casters for stationary use.
- ❑ Weight – 59kg.

CT118 DUST COLLECTOR ILLUSTRATED FEATURES

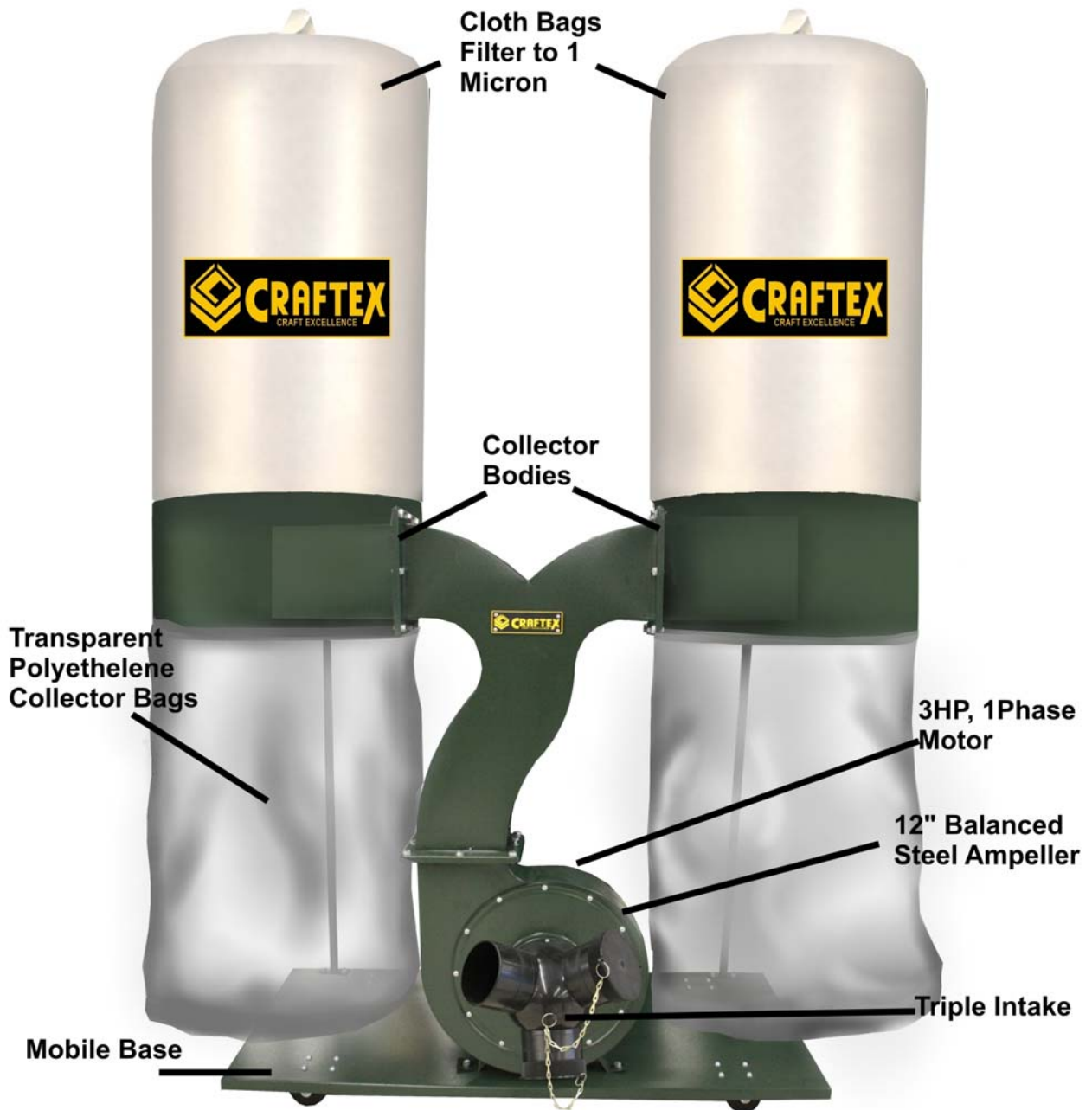

CT118 DUST COLLECTOR UNPACKING

Your Craftex CT118 Dust Collector is shipped in one carton and care should be taken to make certain all components are carefully removed.

The parts include:

Motor/Impeller and Motor Switch Assembly.

Two Collector Bodies.

Mobile Base Unit & Casters.

Triple Blast Gat 4”.

Collector Base.

Collector Supports.

Bag Supports.

Two Filter Bags.

Two Collector Bags.

Steel Straps & Gates.

Assembly Nuts & Bolts.

Owners Manual.

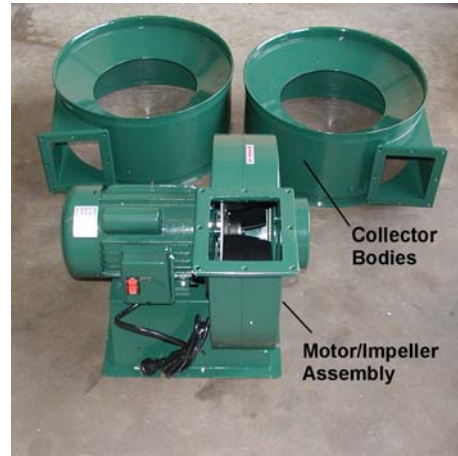

CT118 DUST COLLECTOR ASSEMBLY INSTRUCTIONS

Base Plate Assembly

You will first want to start by assembling the base and casters.

Select the Base Plate and turn it upside down. Select the 4 Casters and fasten to the Base Plate underside as illustrated. Select the appropriate nuts from the Parts Bag and tighten securely with the Metric Wrench provided.

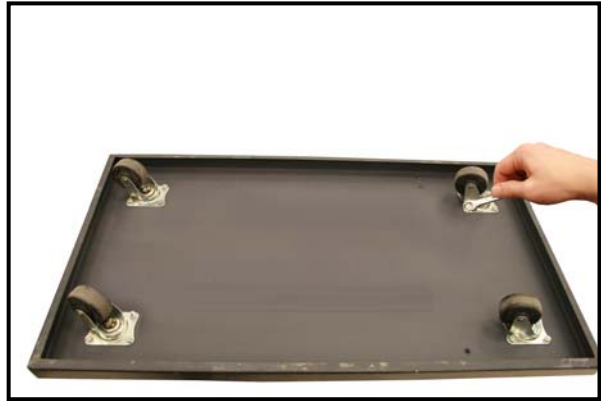

Motor/Impeller Assembly

Turn the Base Plate to its upright position and select the Motor/Impeller Assembly. Mount the Motor/Impeller Assembly to the Base Plate by locating the appropriate holes. Fasten the Assembly with the nuts, bolts and washers provided and tighten securely with the Metric Wrench.



CT118 DUST COLLECTOR Assembly Instructions, Continued

Collector Assembly

Select the Rubber Gasket and the 8 Gasket Screws and Washers from the Parts Package. Place the Rubber Gasket on the flange opening of the Motor/Impeller Assembly as shown.

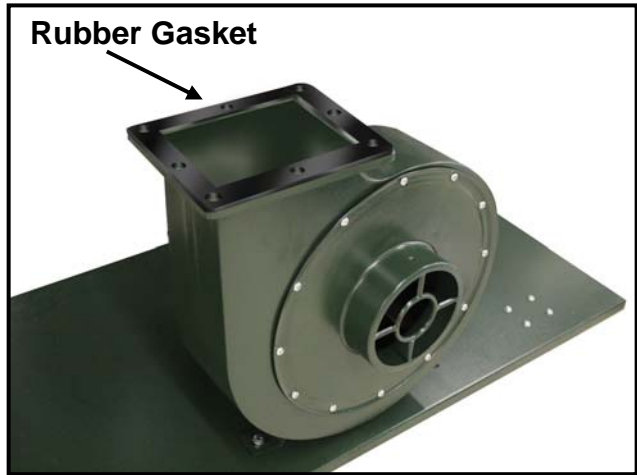

Select the Collector Body and carefully mount it on top of the flange opening being cautious so as to prevent damage to the Gasket.

Using the 8 Gasket Screws, Nuts and Washers, securely fasten the Collector Body to the Motor/Impeller Assembly.



CT118 DUST COLLECTOR

Assembly Instructions, Continued

Installing the Collector Bag Housing

Select the 2 Collectors, 2 Gaskets and 16 Nuts, Bolts and Washers from the Parts Package.

Place one Gasket and a Collector on the Collector Body outlet as illustrated and tighten securely.

Repeat the above with the second Collector.



This figure illustrates how the assembly of the CT118 Dust Collector should appear at this point.



CT118 DUST COLLECTOR Assembly Instructions, Continued

Assembling the Collector Supports

Select the 2 Collector Supports and assemble the lower flange to the Base Assembly using the appropriate nuts, bolts and washers as indicated.



Assemble the tops of the Collector Supports to the Collector Frames using the appropriate nuts, bolts and washers as illustrated.



CT118 DUST COLLECTOR Assembly Instructions, Continued

Figure below shows the CT118 Dust Collector as the assembly should appear up to this point.

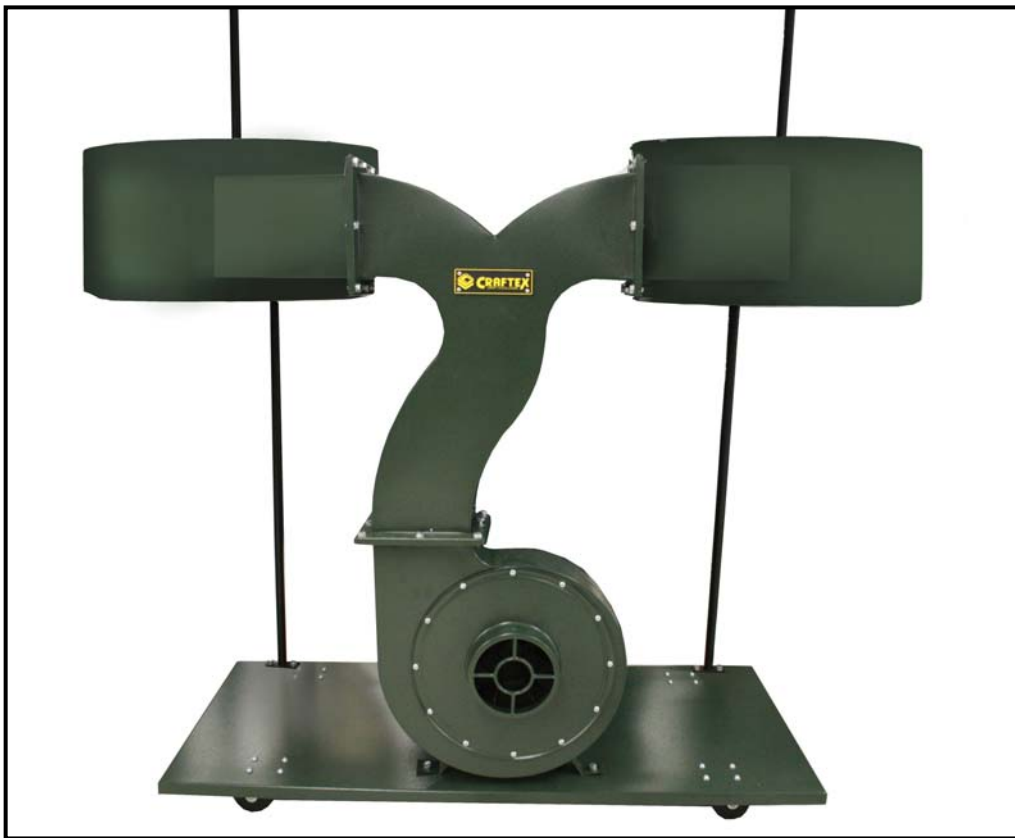

CT118 DUST COLLECTOR

Assembly Instructions, Continued

Installing the Filter and Collector Bags, Continued

Select the 2 Filter Bags and, using the loops on the bottom of the bags, hang them on Support Rods.



Attach the Filter Bags to the recesses in the top of the Collectors using the straps sewn into the bags and tighten.

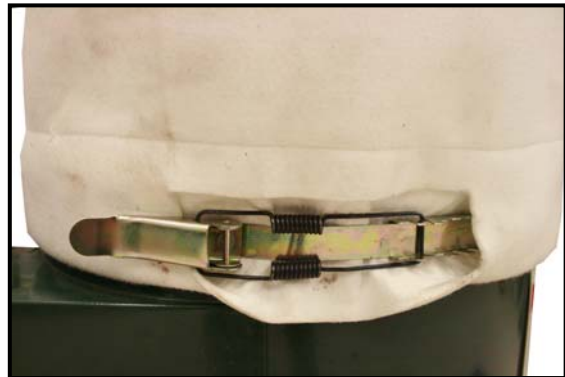

Repeat this procedure in the recesses in the bottom of the Collectors with the polyethylene Collector Bags.

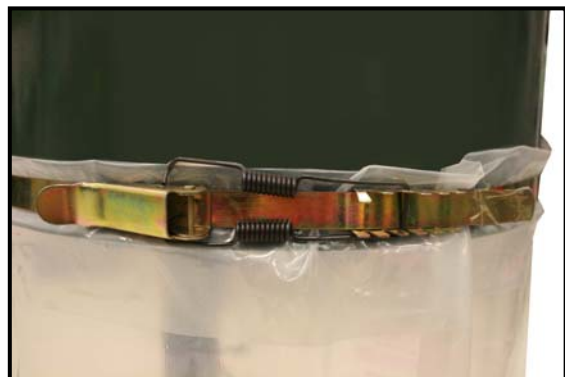

CT118 DUST COLLECTOR

Assembly Instructions, Continued

Installing the Triple Gate Assembly

Select the Triple Gate unit and a self-tapping screw. Mount the Gate on the flange of the Impeller with the two screw holes aligned. Use the self-tapping screw to secure the unit.



The Completed Craftex CT118 Dust Collector

Your Dust Collector is now ready to be put into service. Before connecting to a power source be sure that the power source is correctly grounded and of the correct voltage and amperage.



CT118 DUST COLLECTOR GROUNDING (Optional)

Craftex offers an OPTIONAL grounding system with the CT118 to decrease the shock hazard (although extremely rare). The sawdust being collected becomes very dry as it travels through the collection pipes or tubes and as it spins through the system it creates a static charge. If this is not grounded, it could give the tool operator a static shock. Although the electrical shock is extremely minor, it may have consequences to some individuals.

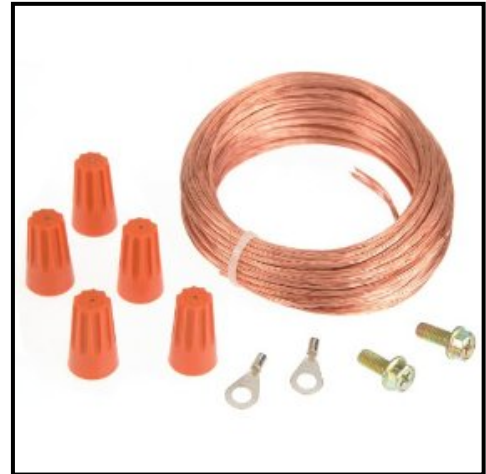

Grounding Kit Model # W1053

The grounding of the pipes or tubes will help eliminate the possibility of these shocks. The copper wire included with the grounding kit should be connected to the steel chassis of the dust collector and fed through a small hole made in the tubing or pipe. The wire should then be fed to the tool being used and grounded to the steel chassis. Should there be more than one tool connected (through gates) to the CT118, they should all be grounded as described above.

For more information in regards to this, you may refer to the 'Dust Collection Basics' book, model W1050. This book covers all topics in regards to home dust collection for the workshop.

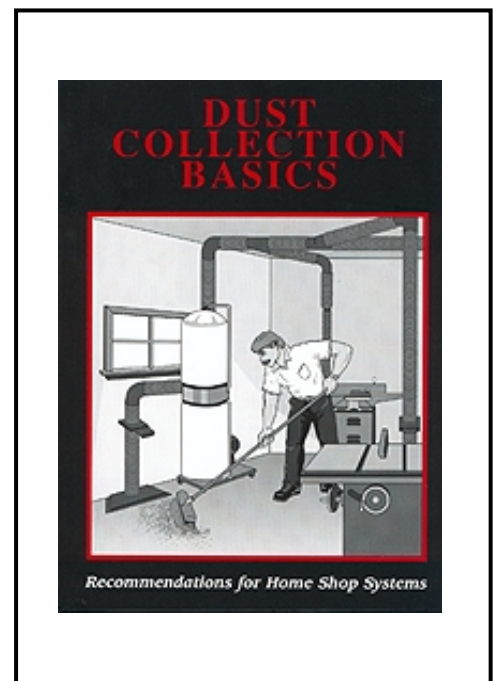

*Dust Collection Basics Book
Model # W1050*

Useful Notes

Wood dust can be very dangerous if one is exposed to it very often. As dust collection had gained popularity over the years, so has consumer knowledge about this concern, but it is always good to know just how dangerous wood dust can be if overexposure and or unsafe woodworking practice takes place.

Health Risk and Hazards that can be caused by exposure to wood dust include the following:

- Asthma
- Eye Irritation
- Hypersensitivity
- Skin Irritation
- Dermatitis
- Suberosis
- Acute Airway Obstructions
- Chronic Bronchitis
- Granulomatous Pneumonitis
- Nasal Cancer

Formulas

Velocity (FPM) = Volume (CFM) / Cross Sectional Area (ft.²)

Volume (CFM) = Velocity (FPM) x Cross Sectional Area (ft.²)

Cross Sectional Area (ft.²) = Volume (CFM) / Velocity (FPM)

Circle Area = 3.142 x Radius²

Diameter = 2 x Radius

CT118 DUST COLLECTOR SCHEMATIC DIAGRAM

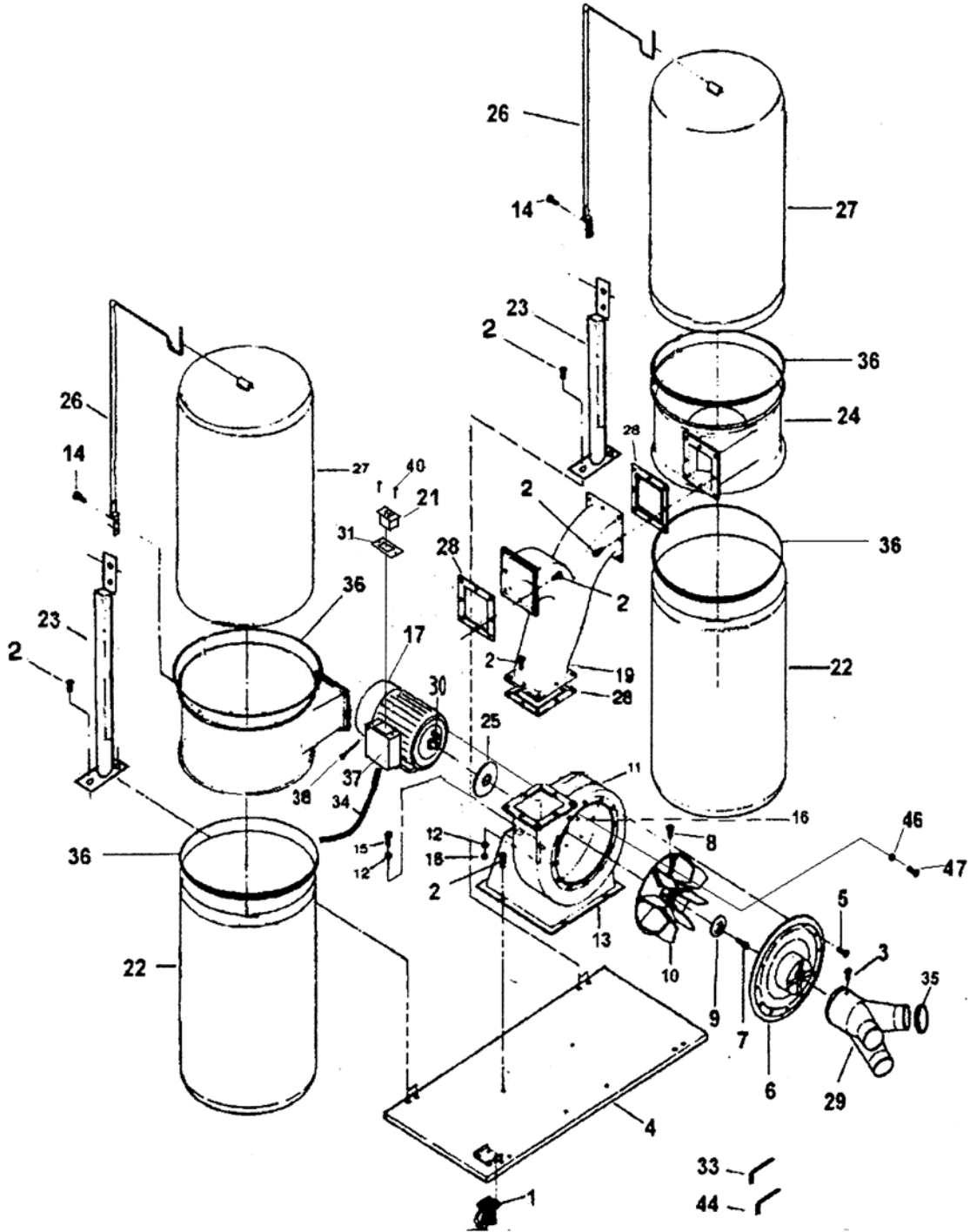

CT118 DUST COLLECTOR PARTS LIST

No.	Description	Part Number	Qty.
1	Caster		4
2	Hex Screw	5/16 x 1/2"	48
3	*		
4	Base Plate		1
5	Pan Head Screw	10-24 x 3/8"	12
6	Inlet Cover		1
7	Hex Head Screw	M6 1.0 x 19mm	1
8	Hex Head Screw	3/8" x 1/2"	2
9	Washer		1
10	Impeller, 12"		1
11	Collector Body		1
12	Washer	5/16"	8
13	Pan Head Screw	10-24 x 1"	2
14	Hex Head Screw	5/16" x 3/4"	4
15	Hex Head Screw	5/16" x 1"	4
16	Motor Switch		1
17	Motor		1
18	Nut	5/16"	4
19	Collector Body		1
20	*		
21	Left Collector		1
22	Collector Bag		2
23	Collector Support		2
24	Right Collector		1
25	Gasket		1
26	Upper Bag Support		2
27	Filter Bag		2
28	Gasket		3
29	Triple Gate		1
30	Key	7mm x 7mm x 28mm	1
31	Power Cord		1
32	Wrench	12mm	1
33	Hex Wrench	5mm	1

OPTIONAL ACCESSORIES

PVC FLEX HOSE

PH003 - 3" PVC Pipe ~ per foot, or 50 ft. Roll

PH004 - 4" PVC Pipe ~ per foot, or 50 ft. Roll

PH005 - 5" PVC Pipe ~ per foot, or 50 ft. Roll



Dust Accessories Kit For 4" Fittings

Model – W1055

Kit #2 to service two machines
Two blast gates, two 10' hoses, one table saw hood, one universal hood, one "Y" fitting, ten hose clamps
17 pieces



Dust Accessories Kit For 4" Fittings

Model – W1054

Kit #1 to service one machine
10' hose, one universal hood, two hose clamp
4 pieces



Replacement Steel Straps for CT118

Model – CT037 – 2pc

Model – CT038 – 4pc

Replacement Bags for CT118

Model - CT033 – 1 micron cloth bag

Model - CT035 Bottom Plastic Bag (5pc)



Canister Filter

CT095CH - Canister Filter for 2HP and 3HP
Dust Collectors



Dust Collection Cyclone Separator

Converts single stage to a two stage system. Designed to fit on standard trash cans. 20-21" D Top. Molded A.B.S fitting puts larger particles in first stage to allow easier disposal.

Model # W1049

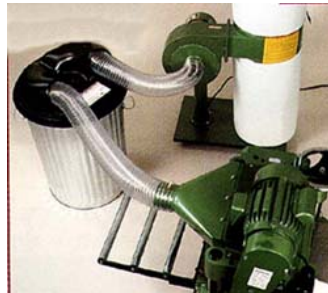



WARRANTY

CRAFTEX 3 YEAR LIMITED WARRANTY

Craftex warrants every product to be free from defects in materials and agrees to correct such defects where applicable. This warranty covers **three years** for parts and 90 days for labour (unless specified otherwise), to the original purchaser from the date of purchase but does not apply to malfunctions arising directly or indirectly from misuse, abuse, improper installation or assembly, negligence, accidents, repairs or alterations or lack of maintenance.

Proof of purchase is necessary.

All warranty claims are subject to inspection of such products or part thereof and Craftex reserves the right to inspect any returned item before a refund or replacement may be issued.

This warranty shall not apply to consumable products such as blades, bits, belts, cutters, chisels, punches etceteras.

Craftex shall in no event be liable for injuries, accidental or otherwise, death to persons or damage to property or for incidental contingent, special or consequential damages arising from the use of our products.

RETURNS, REPAIRS AND REPLACEMENTS

To return, repair, or replace a Craftex product, you must visit the appropriate Busy Bee Tools showroom. Craftex is a brand of equipment that is exclusive to Busy Bee Tools.

For replacement parts directly from Busy Bee Tools, for this machine, please call 1-800-461-BUSY (2879), and have your credit card and part number handy.

- All returned merchandise will be subject to a minimum charge of 15% for re-stocking and handling with the following qualifications.
- Returns must be pre-authorized by us in writing.
- **We do not accept collect shipments.**
- Items returned for warranty purposes must be insured and shipped pre-paid to the nearest warehouse (see locations on inside back cover of this manual).
- Returns must be accompanied with a copy of your original invoice as proof of purchase. Returns must be in an un-used condition and shipped in their original packaging a letter explaining your reason for the return. Incurred shipping and handling charges are not refundable.
- Busy Bee will repair or replace the item at our discretion and subject to our inspection.
- Repaired or replaced items will be returned to you pre-paid by our choice of carriers.
- Busy Bee reserves the right to refuse reimbursement or repairs or replacement if a third party without our prior authorization has carried out repairs to the item.
- Repairs made by Busy Bee are warranted for 30 days on parts and labour.
- Any unforeseen repair charges will be reported to you for acceptance prior to making the repairs.
- The Busy Bee Parts & Service Departments are fully equipped to do repairs on all products purchased from us with the exception of some products that require the return to their authorized repair depots. A Busy Bee representative will provide you with the necessary information to have this done.
- For faster service it is advisable to contact the nearest Busy Bee location for parts availability prior to bringing your product in for repairs.